

OWNER'S MANUAL

THREE PHASE DUCTED INVERTER

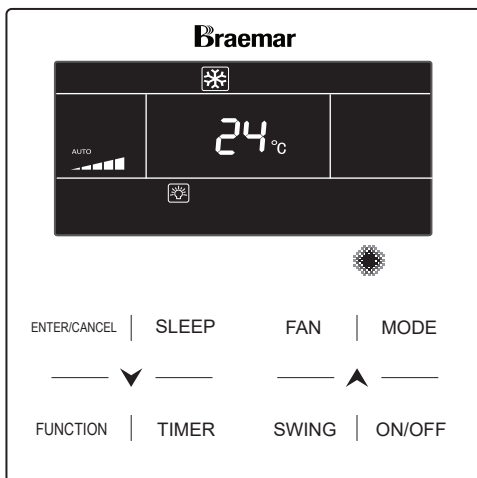

(English) (SDHV SERIES)

IMPORTANT

As with any product that has moving parts or is subject to wear and tear, it is **VERY IMPORTANT** that you maintain your air conditioner and have it regularly serviced. Accordingly, it is a condition of warranty cover for your air conditioner that you comply with all of the maintenance and service requirements set out in this Manual. Compliance with these requirements will prolong the life of your air conditioner. Further, it is also a condition of warranty cover that the Maintenance Schedule in the Manual is filled out (by signing and dating it in the places indicated) when the item is completed. **ANY FAILURE TO CARRY OUT THE REQUIRED MAINTENANCE AND SERVICING, AND ANY FAILURE TO FILL OUT THE MAINTENANCE SCHEDULE, WILL VERY LIKELY VOID YOUR WARRANTY.**

(For complete warranty terms, refer to the separate Warranty Booklet sold with the product. Alternatively, visit www.braemar.net.au to download the terms. Warranty terms are subject to property access and industry safety standards.)

CONTENTS

MAIN COMPONENTS.....	2
INTRODUCTION & SAFETY	3
OPERATION	
WIRED CONTROLLER.....	4
CONTROLLER LAYOUT.....	4
LCD ICONS.....	5-6
BUTTON FUNCTIONS.....	7
ON/OFF	7
MODE, TEMPERATURE, FAN SETTING	8-9
TURBO SETTING.....	10
TIMER SETTING.....	11-13
AIR EXCHANGE SETTING	14-15
SLEEP SETTING.....	15
SAVE FUNCTION SETTING	16
FILTER REMINDER SETTING	17
QUIET FUNCTION SETTING	18
X-FAN SETTING	19
ABSENCE SETTING	19
LOCK FUNCTION SETTING.....	19
REMOTE SHIELD FUNCTION.....	19
GATE CONTROL FUNCTION.....	19-20
LIGHT ON/OFF SETTING	20
ERROR DISPLAY.....	20
ERROR CODES.....	21-23
DEBUGGING CODES.....	24
STATUS CODES.....	25
MAINTENANCE & SERVICE	26
MAINTENANCE SCHEDULE	27
OPERATION TIPS.....	28
TROUBLESHOOTING	29

MAIN COMPONENTS

INDOOR UNIT

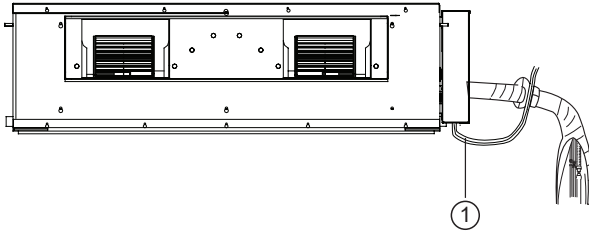

OUTDOOR UNIT

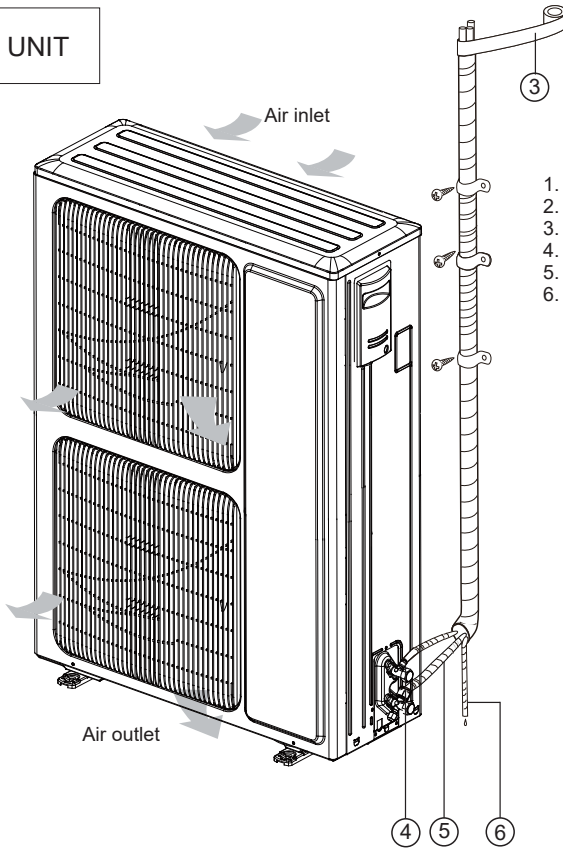

- 1. Power Cord
- 2. Wired Controller
- 3. Binding tape
- 4. Liquid Pipe
- 5. Gas Pipe
- 6. Drain Pipe

INTRODUCTION & SAFETY

Congratulations on purchasing a new Braemar Air Conditioner!

Please keep this Manual and the Warranty Booklet in a safe place, along with the original purchase documents, plus all relevant certificates of compliance relating to the installation work performed. Please register the Warranty straight away, by following the steps set out in the Warranty Booklet.

The installer must read the Installation Manual before installing the Braemar Ducted Inverter Air Conditioning Unit. The home owner/user should read the Owner's Manual before operating the Unit.

To ensure the warranty on the Unit is continued and valid, the Unit must be checked and serviced by the home owner/user as per the requirements in the Maintenance & Service section and the Maintenance Schedule. This will also prolong the life of your air conditioner.

The home owner/user should regularly check the Air Inlet side of the Outdoor unit (see the diagram on page 2) to ensure grass, leaf and other matter are not drawn into or onto the Inlet side of the Outdoor unit. Restriction to the air flow across the coil will reduce the system's capacity, and result in high operation pressures and excessive operating costs.

A return air filter **MUST** be installed by the installer at the return air grille. The air filter should be inspected and cleaned at least every two weeks

when the Braemar Ducted Inverter Air Conditioning Unit is used. Note: the manufacturer recommends that low level return air grilles are installed.

IMPORTANT!

THE AUSTRALIAN GREENHOUSE OFFICE HAS ISSUED VARIOUS REGULATIONS ON THE USE AND DISPOSAL OF REFRIGERANTS IN THE UNIT. FAILURE TO FOLLOW THESE REGULATIONS MAY HARM THE ENVIRONMENT AND COULD LEAD TO THE IMPOSITION OF SUBSTANTIAL FINES.

WHERE SPECIFIED, ONLY QUALIFIED AND LICENSED TECHNICIANS SHOULD PERFORM WORK ON THIS UNIT, FAILING WHICH THE WARRANTY ON THE UNIT WILL BE VOID.

WARNING! This appliance is not intended for use by persons (including children) with reduced physical, sensory or mental capabilities, or lack of experience and knowledge, unless they have been given supervision or instruction concerning use of the appliance by a person responsible for their safety.

Children should be supervised to ensure that they do not play with the appliance.

If the supply cord is damaged, it must be replaced by the manufacturer, its service agent or similarly qualified persons in order to avoid a hazard.

OPERATION

Your Braemar Ducted Inverter Air Conditioning Unit has been designed and built with reliable, quality components. To ensure many years of trouble free, dependable service please read the following pages very carefully, and please ensure that you follow all of the instructions.

WIRED CONTROLLER

Please follow the below cautionary notes when using the wired controller:-

1. Do not install the wired controller in a damp place or under direct sunlight.
2. Do not abuse, toss, or frequently assemble/disassemble the wired controller.
3. Do not operate the wired controller with wet hands and never let any liquid flow into it.
4. Do not install or remove the wired controller by yourself. If necessary, please contact a service agent.
5. This wired controller is applicable to various kinds of air conditioners - some specific functions unavailable to the duct type air conditioners will be covered in this manual.
6. Before operating the air conditioner, please read this manual carefully and keep it in a safe place for future reference.

CONTROLLER LAYOUT

Appearance and LCD Icons

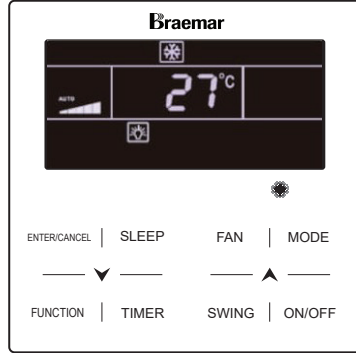



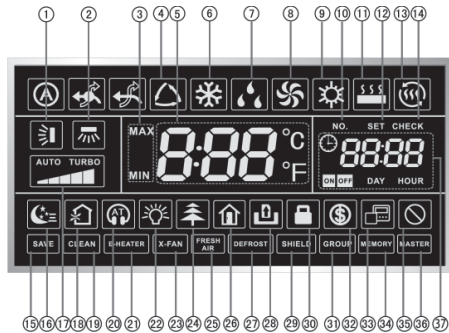















Wired Controller appearance



LCD Icon Layout



















OPERATION cont.

LCD ICONS

No.	Icons	Introduction
1		Up and down swing function (NOT APPLICABLE)
2	 *	Left and right swing function (NOT APPLICABLE)
3		Temperature upper limit in save function: cooling/heating Temperature lower limit in save function: cooling/heating
4		Auto mode
5		Displays the setting temperature
6		Cooling mode
7		Dry mode
8		Fan mode
9		Heating mode
10		Displays number of the indoor unit
11	 *	Floor Heating mode (NOT APPLICABLE)
12		Display “SET” icon under parameter setting interface
13		Space Heating mode (NOT APPLICABLE)
14		Display “CHECK” icon under parameter view interface
15		Outdoor unit operates under Save mode
16		Sleep status
17		Current set fan speed
18		Air status, Indoor unit (OPTIONAL FUNCTION)
19		Reminder to clean the filter

OPERATION cont.

LCD ICONS cont.

20		Quiet status (including Quiet and Auto Quiet)
21		Allow auxiliary electric heating On icon (NOT APPLICABLE)
22		Light On/Off function wired wall controller
23		X-fan function
24		Health function, Indoor unit optional function
25		Reserved function (NOT APPLICABLE)
26		Absence function
27		Outdoor unit defrosting status
28		Gate-control function (OPTIONAL FUNCTON)
29		Shielding status
30		Child Lock status
31		Group Function (NOT APPLICABLE)
32		Save status of indoor unit
33		It indicates the current wired slave controller
34		Memory status
35		Invalid operation
36		Current wired controller connects master indoor unit
37		Timer zone: Display system clock and timer status
<p>*NOTE: When wired controller is connected with different indoor units, some functions will be different</p>		

OPERATION cont.

BUTTON FUNCTIONS

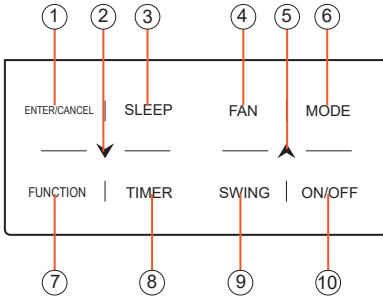

No.	Buttons	Instructions
1	ENTER/CANCEL	Select and cancel function
2	▼	(1) Set operating temperature of indoor unit
5	▲	(2) Set Timer (3) Switch Quiet mode, Air grade, Clean grade, set upper and lower temperature limit under Save mode (4) Set and inquiry parameter
3	SLEEP	Set Sleep mode
4	FAN	Switch among auto, low speed, Slow-medium speed, medium speed, medium-high speed, high speed and turbo status
6	MODE	Switch Auto, Cooling, Dry, Fan, Heating, Floor Heating, 3D Heating and Space Heating modes for indoor unit. (Note: Some functions are not applicable to this unit)
7	FUNCTION	Switch among Air, Quiet, Light, Health, Absence, Save, Clean, E-heater and X-fan functions
8	TIMER	Timer setting
9	SWING	Set up and down swing status
10	ON/OFF	Indoor unit ON/OFF
2+5	▼ + ▲	Simultaneously press “▼” and “▲” for 5s to enter or cancel the Child Lock function

ON / OFF

Press the On/Off button to turn the unit on or off.

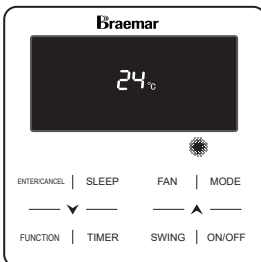

OFF State of the Unit

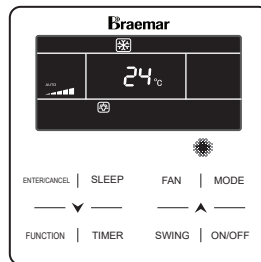

ON State of the Unit

OPERATION cont.

MODE SETTING

Under the ON state of the unit, press the Mode button to switch the operation modes as the sequence shown below.

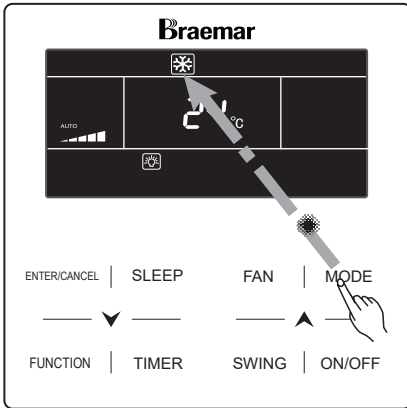
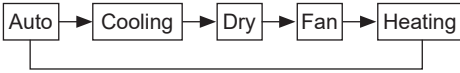

TEMPERATURE SETTING cont.

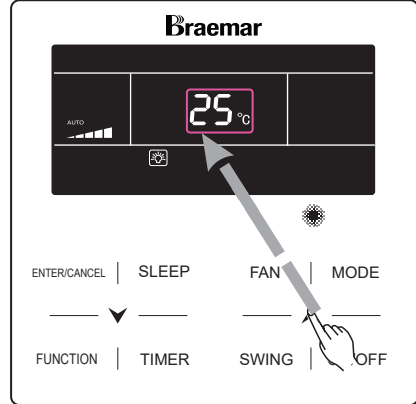

TEMPERATURE SETTING

Press “▼” or “▲” button to increase or decrease setting temperature when the unit is on. Pressing either of them continuously, will increase or decrease by 1°C every 0.3s.

In Cooling, Dry, Fan and Heating mode, temperature setting range is 16°C - 30°C.

In Auto mode, the setting temperature is not adjustable.

OPERATION cont.

FAN SPEED SETTING

Press the FAN button to vary the speeds as shown in the sequence below.

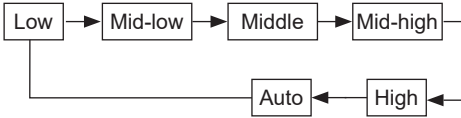

FAN SPEED SETTING cont.

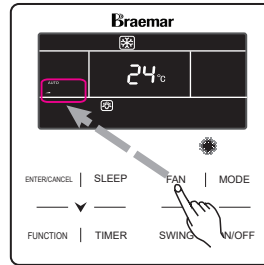

Press FAN button to adjust the fan speed

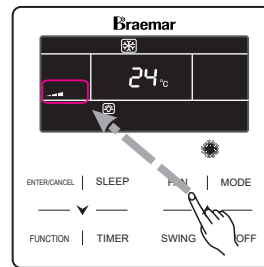

Press FAN button again to increase fan speed

OPERATION cont.

TURBO SETTING

Press FUNCTION button to switch to “TURBO” function. The TURBO icon will flash. Press the ENTER/CANCEL to start function. When the “TURBO” function is activated the “TURBO” icon will be displayed.

To deactivate the “TURBO” function press the FUNCTION button to switch to “TURBO” function, then press the ENTER/CANCEL button to deactivate.

NOTE:

- 1 In DRY mode, fan speed cannot be adjusted.
- 2 When the wired controller is connected with a fresh air unit fan speed of the indoor unit cannot be adjusted via FAN button.
- 3 If the indoor unit's fan speed is set the fan speed will automatically adjust according to the room temperature.

TURBO SETTING cont.

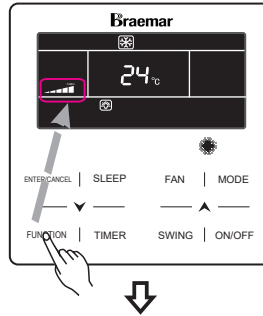

When in FAN setting Press FUNCTION button to enter the TURBO mode

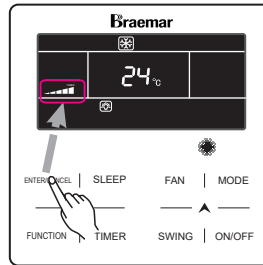

Press ENTER/CANCEL button to activate the TURBO mode

OPERATION cont.

TIMER SETTING

GENERAL TIMER

Timer On Setting

When the unit is OFF, press the TIMER button, afterwards “HOUR” will be displayed, press “▼” or “▲” to adjust the timer, then press the TIMER button to confirm.

Timer Off Setting:

When the unit is ON, press the TIMER button. xx HOUR is displayed and will flash, press “▼” or “▲” to adjust the timer, press the TIMER button to confirm.

CLOCK SETTING

When the timer, timer zone, timer zone functions are activated. The “🕒” icon will appear, the clock can be set during this time.

Press the TIMER button for 15s to enter the clock setting. The “🕒” icon will appear press the “▼” or “▲” button to increase or decrease the clock time by 1 min intervals. Holding down “▼” or “▲” will increase or decrease the clock time by 10 mins. Press the ENTER/CANCEL to save the setting and exit.

NOTE:

For the GENERAL TIMER setting to activate, Parameter setting P33 will need to be set during installation. If the GENERAL TIMER cannot be activated consult the installation manual.

TIMER SETTING cont.

Timer “ON/OFF” Setting when the Unit is ON is as shown below.

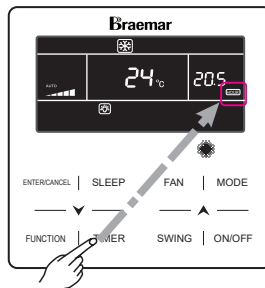

Press TIMER button to enter timer setting

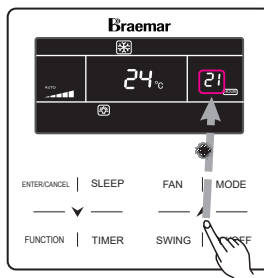

Press “▼” or “▲” button to adjust timer

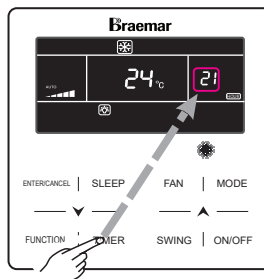

Press TIMER button to activate timer function

OPERATION cont.

CLOCK TIMER

The CLOCK TIMER allows you to set the time of the day for the air conditioner to switch on or off.

Setting the CLOCK TIMER function

To program the air conditioner to switch on at the desired time. Press the TIMER button to enter timer function, the “ON” icon will appear. Press “▼” or “▲” to set the desired time to turn on the air conditioner. Press the TIMER button to confirm the ON time.

Next the “OFF” icon will appear Press “▼” or “▲” to set the desired time to switch off the air conditioner. Press TIMER to confirm.

Cancel timer

To cancel the clock ON timer, Press the TIMER function to enter setting. Press the ENTER/CANCEL to cancel clock ON timer.

To cancel the clock OFF timer, Press the TIMER function to enter setting. Press the ENTER/CANCEL to cancel clock OFF timer.

NOTE:

Pressing “▼” or “▲” button increases or decrease the timer time by 1 min intervals. Holding “▼” or “▲” button for 5s increases or decreases the time by 10 min intervals.

CLOCK TIMER cont.

CLOCK TIMER “On/Off” setting is shown below

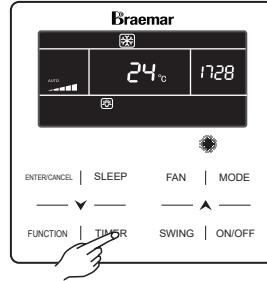

Press TIMER button to enter timer setting

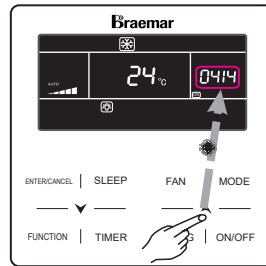

Press “▼” or “▲” button to adjust timer

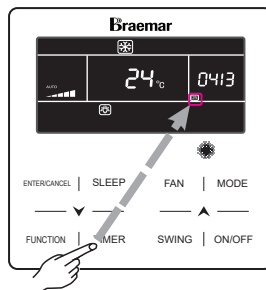

Press TIMER button to activate clock ON timer function

OPERATION cont.

CLOCK TIMER cont.

CLOCK TIMER “On/Off” setting is shown below

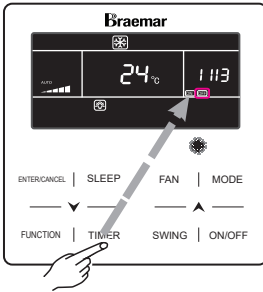

Press TIMER button to switch to unit off time setting

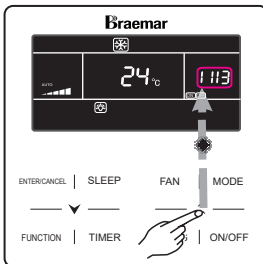

Press “▼” or “▲” button to adjust timer

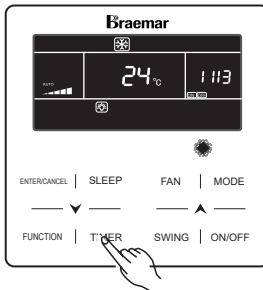

Press TIMER button to activate clock OFF timer function

CLOCK TIMER cont.

NOTE:

For the CLOCK TIMER setting to activate, Parameter setting P33 will need to be set during installation. If the CLOCK TIMER cannot be activated consult the installation manual.

OPERATION cont.

AIR EXCHANGE SETTING

When the unit is ON, press the FUNCTION button to select "AIR" function, the "AIR" function icon will flash, press "▲" or "▼" to adjust the "AIR" type. Press the ENTER/CANCEL button to activate.

Setting 1-9: The unit runs continuously for 60 minutes, fresh air valve runs for 6 minutes (setting 1) to 54 minutes (setting 9), in 6 minute increments.

Setting 10: The Unit runs continuously for 60 minutes, fresh air valve always runs.

To deactivate the "AIR" function press FUNCTION then select "AIR" with the "AIR" icon flashing, press the ENTER/CANCEL button. The "AIR" icon will disappear.

Air Exchange setting is shown below.

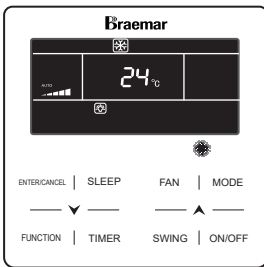

Unit On, no AIR function



AIR EXCHANGE SETTING cont

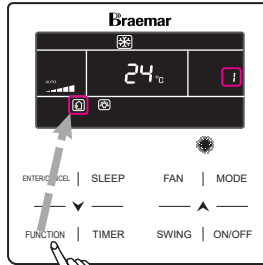

Press FUNCTION button to set AIR function

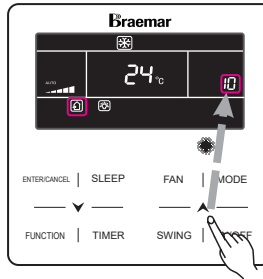

Press "▼" or "▲" button to adjust air mode

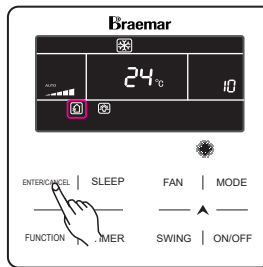

Press ENTER/CANCEL to activate function

OPERATION cont.

AIR EXCHANGE SETTING cont

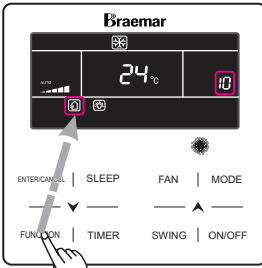

Press FUNCTION button to activate AIR function

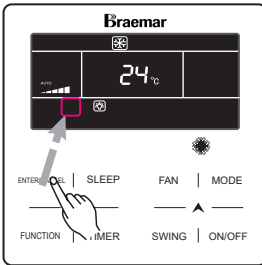

Press ENTER/CANCEL button to cancel AIR function

SLEEP SETTING

Sleep on: Press the SLEEP button to activate the "SLEEP" function.

Sleep off: When the "SLEEP" function is activated, press the SLEEP button to deactivate "SLEEP" function.

NOTE:

1. Under auto, Fan, or Floor Heating mode, this SLEEP function is not available.
2. When the SLEEP function is canceled. If the QUIET function is still activated before activating the SLEEP function, only the SLEEP function will be deactivated.

SLEEP SETTING cont

Sleep setting is as shown below.

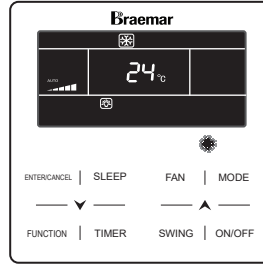

Unit On, no SLEEP function

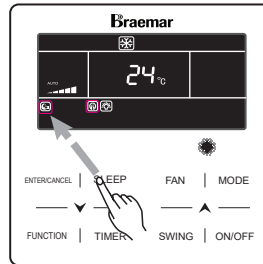

Press SLEEP button to activate SLEEP function

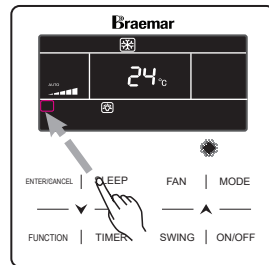

Press SLEEP button to deactivate SLEEP function

OPERATION cont.

SAVE FUNCTION SETTING

The SAVE setting will make the air conditioner operate in a smaller temperature range by limiting the lower temperature value in the COOL or DRY mode and upper value in HEAT mode.

1. Energy Saving Setting for Cooling:
When the unit runs under the COOL or DRY mode, press the FUNCTION button to select the "SAVE" function. With "SAVE" icon flashing, press "▼" or "▲" to adjust the lower limit, then press ENTER/CANCEL to confirm.

2. Energy Saving Setting for Heating:
When the unit runs under the HEAT mode, press the FUNCTION button to select the "SAVE" function, with the "SAVE" icon flashing, press "▼" or "▲" to adjust the lower limit, then press ENTER/CANCEL to confirm.

The "SAVE" function can be deactivated by pressing the FUNCTION button to select the "SAVE" then press the ENTER/CANCEL button.

The energy save setting is as shown below.

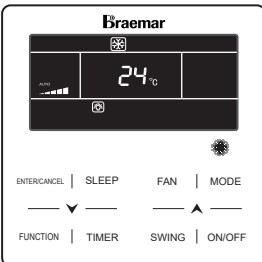

Unit On, no SAVE function

SAVE FUNCTION SETTING cont.

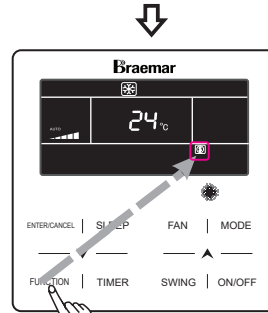

Press FUNCTION button to set energy SAVE temperature for Cooling

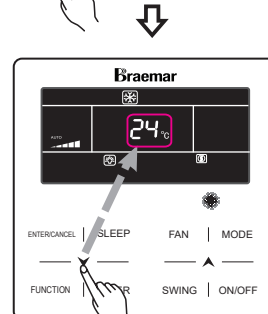

Press "▼" or "▲" button to adjust temperature

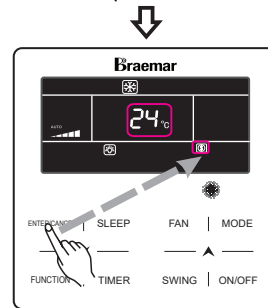

Press ENTER/CANCEL to activate SAVE function

NOTE:

When the "SAVE" function is turned on and the set temperature exceeds the set limit. The "Ⓢ" icon will flash three times followed by 2 "beeps".

OPERATION cont.

FILTER REMINDER SETTING

Turn on Filter Clean Reminder Function: When unit is on, press FUNCTION button and select Filter Clean Reminder. The “CLEAN” icon will flash. Press “▼” or “▲” button to adjust the cleaning level, between 10-39. Press ENTER/CANCEL to activate this function.

Turn off Filter Clean Reminder Function: When unit is on and this function has been activated, press FUNCTION button and select “CLEAN”. The “CLEAN” icon will flash. Set the cleaning level as 00 and press ENTER/CANCEL to deactivate.

“FILTER” function setting is shown below.

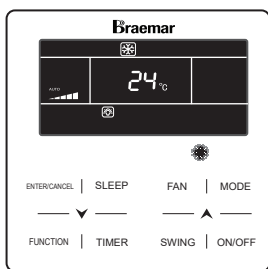

FILTER SETTING cont.

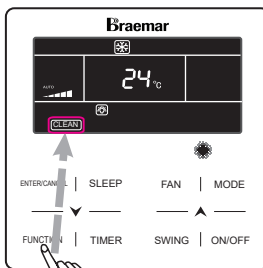

Press Function button to set FILTER function

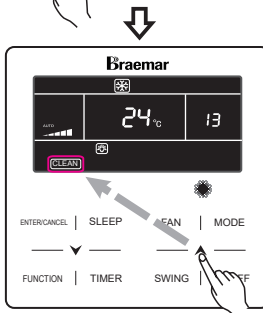

Press “▼” or “▲” button to set the desired level

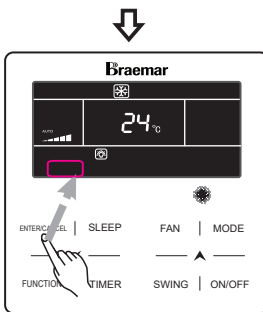

Press Enter/Cancel button to activate FILTER function

NOTE:

When Filter Clean Reminder activates, the “CLEAN” icon will light up to remind you to clean the filter. Press the FUNCTION button to select the Filter Clean Reminder Function, then press ENTER/CANCEL to dismiss the reminder, this will reset the filter reminder.

OPERATION cont.

QUIET FUNCTION SETTING

Press the FUNCTION button to select “QUIET” function. The “QUIET” icon will flash. Press ENTER/CANCEL button to activate.

When the “QUIET” function is activated, press the FUNCTION button to select “QUIET” icon, press ENTER/CANCEL button to deactivate “QUIET” function.

NOTE:

“QUIET” function is available only in Auto, Cooling Dry Fan, Heating, 3D Heating, Space Heating mode.

QUIET FUNCTION SETTING cont.

“QUIET” function setting is as shown below.

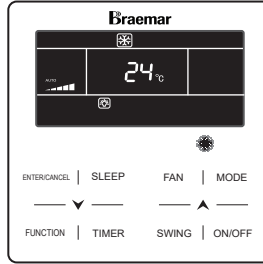

Unit On, no QUIET function

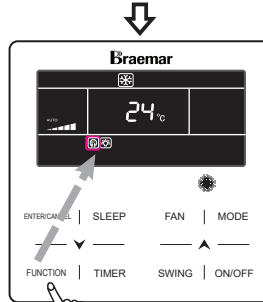

Press FUNCTION button to set QUIET function

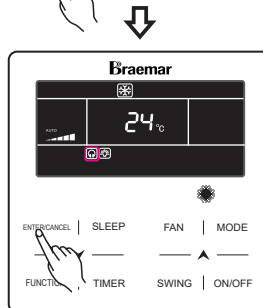

Press ENTER/CANCEL button to activate QUIET function

OPERATION cont.

X-FAN SETTING

X-fan Function: If unit is turned off under Cooling or Dry mode, the evaporator coil of indoor unit will be dried off automatically to prevent the build up of bacteria and mold.

Turn on X-fan: When unit is in Cooling or Dry mode, press the FUNCTION button to select “X-fan” function.

The “X-fan” icon will flash.

Then press ENTER/CANCEL button to turn on this function.

Turn off X-fan: When “X-fan” function is on, press FUNCTION button to select “X-fan”. Then press ENTER/CANCEL button to turn off this function.

ABSENCE SETTING

Absence Function: This is used to maintain indoor temperature when occupants are not in the room. This function can only be used under heating mode.

Turn on Absence Function:

Under Heating mode, press FUNCTION button to select Absence.



The “” icon will flash. Then press ENTER/CANCEL button to activate this function.



Turn off Absence Function:

When this function is on, press FUNCTION button to select Absence.

The “” icon will blink. Press ENTER/CANCEL button to turn off this function.

LOCK FUNCTION

When the unit is ON or OFF to activate the LOCK function press  and  buttons at the same time for 5s till the wired wall controller enters the lock state and the LCD displays .



Press  and  buttons at the same time for 5s to quit the lock state.

Under the lock state, pressing any other buttons with give no response.

REMOTE SHIELD FUNCTION

Remote Shield Function: A central controller can disable the control functions of the wired controller. When the shield function is activated the controls on the wired wall controller will be disabled. When the central controller activates the remote shield function the “SHIELD” icon will show.

GATE-CONTROL FUNCTION

When there is Gate-control System, The user can insert a card to turn on the unit or pull out the card to turn off the unit. When the card is re-inserted, the unit will resume operation. When the card is pulled out the “” icon will show. Both the unit as well as the wired remote will not be in operation. The “” icon will flash. (This function is optional and may not be applicable to your unit).

OPERATION cont.

GATE-CONTROL FUNCTION cont.

NOTE:

The model cannot be connected to the gate control system on its own. For the gate control system to be activated it must be connected with a wired controller that includes a gate control signal detecting function.

LIGHT ON/OFF SETTING

Light On/Off Function: Wired Controller. The back light display on the wired wall controller can be turned on or off.

Turn on the Light: When unit is on or off, press FUNCTION button to select Light function.

The “” icon will flash. Press ENTER/CANCEL to turn on light.

Turn off the Light: When unit is on, press FUNCTION button to select Light function.

The “” icon will flash. Press ENTER/CANCEL to turn off light.

NOTE:

When there is no input into the controller for 20s:

1. If Light function is activated, the back light of LCD will turn to half brightness.
2. If Light function is off, the back light of LCD will be turned off.

ERROR DISPLAY

When an error occurs to the unit, the error code will be shown on the wired controller. When multiple errors simultaneously happen, the error codes will be shown cyclically on the display.

When an error occurs, please immediately shut down the unit and contact your Seeley approved service agent.

A typical error message is shown - “E1” means the high pressure protection.

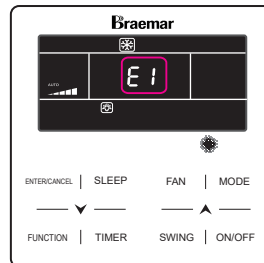

OPERATION cont.

ERROR DISPLAY cont.

Error codes and their meanings are shown below:

ERROR CODES FOR OUTDOOR UNITS

Error Code	Content	Error Code	Content	Error Code	Content
E0	Outdoor Unit Error	FL	Compressor 3 Current Sensor Error	b4	Subcooler Liquid-out Temperature Sensor Error
E1	High Pressure Protection	Fn	Mode Exchanger Inlet Pipe Temperature Sensor Error	b5	Subcooler Gas-out Temperature Sensor Error
E2	Discharge Low Temperature Protection	FP	Malfunction of DC motor	b6	Gas-liquid separator inlet temperature sensor error
E3	Low Pressure Protection	FU	Compressor 2 Top Temperature Sensor Error	b7	Gas-liquid separator outlet temperature sensor error
E4	Excess Discharge Temperature Protection of Compressor	J1	Compressor 1 Over-current Protection	b8	Outdoor Humidity Sensor Error
F0	Bad Performance of the Outdoor Mainboard	J2	Compressor 2 Over-current Protection	b9	Heat Exchanger Gas-out Temperature Sensor Error
F1	High Pressure Sensor Error	J3	Compressor 3 Over-current Protection	bA	Oil-return Temperature Sensor Error
F3	Low Pressure Sensor Error	J4	Compressor 4 Over-current Protection	bC	Compressor 1 Top Temperature Sensor Detachment Protection
F5	Compressor 1 Discharge Temperature Sensor Error	J5	Compressor 5 Over-current Protection	bE	Malfunction of entry tube temperature sensor of condenser
F6	Compressor 2 Discharge Temperature Sensor Error	J6	Compressor 6 Over-current Protection	bF	Malfunction of exit tube temperature sensor of condenser
F7	Compressor 3 Discharge Temperature Sensor Error	J7	4-way Valve Blow-by Protection	bH	System Clock Malfunction
F8	Compressor 4 Discharge Temperature Sensor Error	J8	System Pressure Over-Ratio Protection	bJ	High and low pressure sensors are connected inversely

OPERATION cont.

ERROR DISPLAY cont.

ERROR CODES FOR OUTDOOR UNITS cont.

Error Code	Content	Error Code	Content	Error Code	Content
F9	Compressor 5 Discharge Temperature Sensor Error	J9	System Pressure Under-Ratio Protection	bL	Compressor 2 Top Temperature Sensor Detachment Protection
FA	Compressor 6 Discharge Temperature Sensor Error	JA	Protection of Abnormal Pressure	P0	Compressor Drive Board Error
Fb	Compressor 2 Top Temperature Sensor Error	JC	Protection of Water Flow Switch	P1	Compressor Drive Board Malfunction
FC	Compressor 2 Current Sensor Error	JE	Oil return pipe is blocked	P2	Protection of Compressor Drive Board Power Supply
Fd	Mode Exchanger Outlet Pipe Temperature Sensor Error	JF	Oil return pipe is leaking	P3	Protection of Compressor Drive Board Module Reset
FE	Compressor 4 Current Sensor Error	JL	Protection of Low High-pressure	H0	Error of Fan Drive Board
FF	Compressor 5 Current Sensor Error	b1	Outdoor Ambient Temperature Sensor Error	H1	Malfunction of Fan Drive Board
FH	Compressor 1 Current Sensor Error	b2	Defrosting Temperature Sensor 1 Error	H2	Protection of Fan Drive Board Power Supply
FJ	Compressor 6 Current Sensor Error	b3	Defrosting Temperature Sensor 2 Error		

OPERATION cont.

ERROR CODES FOR INDOOR UNITS

Error Code	Content	Error Code	Content	Error Code	Content
L0	Indoor Unit Error	LF	Shunt Valve Setting Error	d9	Jumper Cap Error
L1	Indoor Fan Protection	LH	Low Air Quantity Warning	dA	Indoor Unit Hardware Address Error
L2	E-heater Protection	LJ	Wrong Setting of Function DIP Switch	dB	Special Code: Field Debugging Code
L3	Water Full Protection	LP	Zero-crossing malfunction of PG motor	dC	Capacity DIP Switch Setting Error.
L4	Wired Controller Power Supply Error	LU	Inconsistent Branch of Group-controlled Indoor Units in Heat Recovery System	dE	Indoor Unit CO2 Sensor Error
L5	Anti-Frosting Protection	d1	Indoor Unit PC-Board Error	dH	Wired Controller PC-Board Error
L7	No Master Indoor Unit Error	d3	Ambient Temperature Sensor Error	dL	Outlet Air Temperature Sensor Error
L8	Power Insufficiency Protection	d4	Inlet Pipe Temperature Sensor Error	dn	Swing Assembly Error
L9	Quantity Of Group Control Indoor Units Setting Error	d5	Malfunction of middle tube temperature sensor	y7	Fresh Air Inflow Temperature Sensor Error
LA	Indoor Units Incompatibility Error	d6	Outlet Pipe Temperature Sensor Error	y8	Indoor Air Box Sensor Error
Lb	Inconsistency of Group-controlled Indoor Units in Reheat Dehumidification System	d7	Humidity Sensor Error	y9	Outdoor Air Box Sensor Error
LC	Outdoor-Indoor Incompatibility Error	d8	Water Temperature Abnormality		

OPERATION cont.

DEBUGGING CODES

Error Code	Content	Error Code	Content	Error Code	Content
U2	Outdoor Unit Capacity Code/Jumper Cap Setting Error	UL	Emergency Operation DIP switch setting of the compressor is wrong	CE	Communication Failure Between Mode Exchanger and Indoor Unit
U3	Phase Sequence Protection of Power Supply	C0	Communication between indoor unit and outdoor unit and the communication between indoor unit and wired controller have malfunction	CF	Error of Multiple Master Indoor Unit
U4	Protection of Lack of Refrigerant	C2	Communication error between master control and inverter compressor drive	CH	Rated capacity is too high
U5	Wrong Address of Compressor Drive Board	C3	Communication error between master control and inverter fan motor drive	CJ	System addresses is incompatible
U6	Valve Abnormal Alarm	C4	Error of Lack of Indoor Unit	CL	Rated capacity is too low
U8	Indoor Unit Tube Malfunction	C5	Alarm of Indoor Unit Project Number Collision	Cn	Indoor and Outdoor Network Error of Mode Exchanger
U9	Outdoor Unit Tube Malfunction	C6	Alarm of Wrong Number of Outdoor Unit	CP	Error of Multiple Master Wired Controller
UC	Master indoor unit is successfully set	C7	Mode Exchanger Communication Error	CU	Communication Error between Indoor Unit and Remote Receiver
UE	Refrigerant Charging is ineffective	Cb	Outflow of Units IP Address	Cy	Communication Error of No Master in Mode Exchanger
UF	Indoor Unit Identification Error of Mode Exchanger	Cd	Communication Failure Between Mode Exchanger and Outdoor Unit		

OPERATION cont.

STATUS CODES

Error Code	Content	Error Code	Content	Error Code	Content
A0	Unit is waiting for debugging	A8	Vacuum-pumping Mode	AJ	Filter Clean Reminder
A1	Check the compressor operation parameters	Ab	Emergency Stop	AU	Remote Urgent Stop
A2	After-sales Refrigerant Reclaim	Ad	Operation Restriction	n3	Compulsory defrosting
A3	Defrosting	AC	Cooling	qE	EVI Operating Mode
A4	Oil return	AF	Fan		
A5	Online Testing	AH	Heating		

MAINTENANCE & SERVICE

AIR FILTER

It is important to check and clean the air filter as per the Maintenance Schedule below. A dirty air filter will not allow the correct amount of clean air to pass through your air conditioner, resulting in poor performance and increased running costs. You should ask the installer to show you where the air filter is located. To clean the air filter, it should be removed and then cleaned with a vacuum cleaner. If it is very dirty, wash it with soapy water and then wipe off. Make sure it is completely dry before refitting it. You should never operate the air conditioner without the air filter in place.

INDOOR COIL (REFER PAGE 2)

It is advisable to have the drain and duct connections checked on an annual basis (as set out in the Maintenance Schedule).

Drains can be blocked by all types of insects, and rats have been known to chew through the drain to get to the water in the pipe.

OUTDOOR UNIT (REFER PAGE 2)

The Outdoor unit has either one or two fans, it draws air through the appliance to expel the heat generated during the cooling cycle. We recommend checking that plants haven't grown into or around the air intake or outlet, along

with other debris that may build up over time, namely, leaves and the like.

REFRIGERANT

The refrigerant is the life blood of your air conditioning unit. Not only does the correct refrigerant charge provide you with reliable and economical cooling, it also provides the cooling for the compressor. A lack of refrigerant, due to a leak, will cause the compressor to overheat and expire prematurely. You will notice a decline in cooling effect and an increase in power consumption. Therefore, having a qualified, licensed technician service your air conditioner will save you money in the long term.

PLEASE REFER TO THE NEXT PAGE FOR THE MAINTENANCE SCHEDULE

MAINTENANCE SCHEDULE

Installation Date:	/	/	Installer:	
--------------------	---	---	------------	--

Items to be done by the Home Owner/User (please sign in the places indicated)							
	Monthly	Annually	Year 1	Year 2	Year 3	Year 4	Year 5
Air filter cleaning	✓						
Air filter replacement		✓					
Maintain required clearance around Outdoor unit		✓					

Items to be done by a Qualified Licensed Technician (Home owner/user must ensure that the technician signs and dates in the places indicated)	
	Annually
Check, clean or replace filter	✓
Check drain from indoor coil	✓
Check Outdoor unit clearances – maintain garden and debris	✓
Check refrigerant charge	✓
Check refrigeration connections for soundness	✓
Check outdoor fans	✓
Check electrical connections	✓
Check ductwork (including but not limited to: duct, fittings, zone dampers, grilles)	✓
Check overall installation	✓
Report to the home owner/user all tasks that require attention	✓

Year 1 – Date:	/	/	Technician:	
Year 2 – Date:	/	/	Technician:	
Year 3 – Date:	/	/	Technician:	
Year 4 – Date:	/	/	Technician:	
Year 5 – Date:	/	/	Technician:	

Please NOTE: the Maintenance Schedule covers Year 1 to Year 5. To preserve your investment for many years afterwards, we strongly recommend that you continue to maintain and service the Braemar Ducted Inverter Air Conditioning Unit as per the items and frequency set out in the Schedule, and as indicated elsewhere in this Manual.

OPERATION TIPS

The following events may occur during normal operation:

1. Protection of the air conditioner.

Compressor protection

- The compressor cannot restart for 3 minutes after it stops.
- The supply air drops below a pre-determined set point; this prevents the indoor coil from freezing.

2. A white mist coming out from the Indoor unit.

- A white mist may generate due to a large temperature difference between air inlet and air outlet on COOL mode in an indoor environment that has a high relative humidity.

3. Low noise of the air conditioner.

- You may hear a low hissing sound when the compressor is running or has just stopped running.

This sound is the sound of the refrigerant flowing or coming to a stop.

- You can also hear a low “squeak” sound when the compressor is running or has just stopped running.

This is caused by heat expansion and cold contraction of the plastic parts in the Unit when the temperature is changing.

4. Dust is blown out from the Indoor unit.

This is a normal condition when the air conditioner has not been used for a long time or during first use of the Unit.

5. A peculiar smell comes out from the Indoor unit.

This is caused by the Indoor unit giving off smells permeated from building material, from furniture, smoke (for example if someone is cooking food), or from the duct work.

6. FAN operation during COOL mode.

When indoor air temperature reaches the setting on the wired wall control, the compressor will stop operating and after approximately 60 seconds the indoor fan will stop blowing air. When the room temperature rises back to the set point, the indoor fan and the compressor will start again.

TROUBLESHOOTING

Problem	Probable Cause	Remedy
1. The air conditioner does not run.	1.1 Power failure. 1.2 Fuse blown or circuit breaker open. 1.3 Thermostat adjustment too low (in heating mode) or too high (in cooling mode).	1.1 Wait for power to resume. 1.2 Replace the fuse or reset the breaker. 1.3 Check thermostat setting.
2. There is insufficient cooling.	2.1 The room was probably very hot when you started the system.	2.1 Wait a while so the Unit has enough time to cool the room.
3. 'Clicking' sound is heard from the air conditioner.	3.1 In heating or cooling operation any plastic parts may expand or shrink due to a sudden temperature change in this event, a clicking sound may occur.	3.1 This is normal.

WARRANTY & SERVICE

For prompt, efficient service, please follow the above before calling the appropriate number below.

For Refrigerated Cooling Issues

1300 526 477

When calling the Warranty Service number, please ensure you have your model and serial number available, along with date of purchase, and if possible a description of the problem.

NOTE:

Seeley International strives for continuous product improvements, therefore specifications are subject to change without notice. Unit colour may vary slightly from that depicted in this booklet.

Installation and commissioning of this system to the manufacturer's specification, and compliance with industry standards, and local, state and national regulatory codes, are the responsibility of the installer.

Information in this booklet was true and correct at the time of publishing. E & OE.

It is the policy of Seeley International to introduce continuous product improvements. Accordingly, specifications are subject to change without notice. Please consult with your dealer to confirm the specifications of the model selected.



Warranty Service
Refrigerated Cooling 1300 526 477
seeleyinternational.com

BraemarTM
By **SEELEY INTERNATIONAL** 