

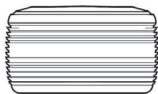

INSTALLATION AND OWNER MANUAL

MagIQtouch WIRELESS Smart Controller



MAGIQTOUCH 
WIRELESS Next Generation Smart Controller

Original English Instructions

TABLE OF CONTENTS

SAFETY

Responsibilities	1
Risk Assessment	1
Warnings	1
FCC Compliance	2

MOUNTING THE MAGIQTOUCH WIRELESS CONTROLLER

Location	3
Mounting the Controller	4

MOUNTING THE MAGIQTOUCH WIRELESS RECEIVER

Heater Installation	7
Heater With Zones	8
Cooler Installation	9
Mounting the Receiver	9

COMMISSIONING

Connecting the Receiver	11
Pairing	11
Pairing Additional Controller	13

WIRELESS CONNECTION

MAINTENANCE	15
Wireless RF Signal Range	18

CONTROLLER OR SYSTEM RESET

2X Controllers Connected	20
--------------------------	----

SUPPORT

USER GUIDE

GENERAL TIPS

REPLACING THE BATTERIES

QUICK START

SLEEP MODE

WIRELESS RANGE

ADDITIONAL CONTROLLER

TROUBLE SHOOTING

KIT CONTENTS

MagiQtouch Wireless Smart Controller

Item	Qty	Description
A	1	MagiQtouch Wireless Smart Controller
B	1	MagiQtouch Wireless Receiver
C	4	AA Batteries
D	1	Install & Operation Manual
E	2	Screw PAN PHIL 6AB*1" ZP
F	2	Wall Plug Yellow (1/4") 5mm

Item A



Item B

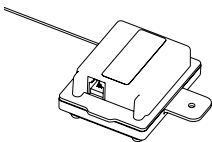

Item C



Item D



SAFETY

This document provides technical guidance on the installation and operation of the MagIQtouch WI-FI smart app.

EMPLOYER AND EMPLOYEE RESPONSIBILITIES

Please read this manual carefully. Your failure to do so could result in injury to you or damage to the cooler and property.

The installation and maintenance of evaporative coolers at height has the potential to create Occupational Health and Safety issues for those involved. Installers are advised to ensure they are familiar with Local Acts, Regulations and Standards, which may offer practical guidance on health and safety issues. Compliance with these regulations will require appropriate work practices, equipment, training and qualifications of workers.

INSTALLER AND MAINTENANCE CONTRACTORS– RISK ASSESSMENT

Seeley International provides the following information as a guide to contractors and employees to assist in minimising risk whilst working at height.

A risk assessment of all hazardous tasks is required under legislation. A risk assessment is an essential element that should be conducted before the commencement of work, to identify and eliminate the risk of falls or to minimise these risks by implementing control measures. There is no need for this to be a complicated process, it just is a matter of looking at the job to be done and considering

what action(s) are necessary so the person doing the job does not injure themselves.

This should be considered in terms of:

- What are the chances of an incident happening?
- What could the possible consequence be?
- What can you do to reduce, or better still, completely get rid of the risk?

WARNINGS!

The MagIQtouch Wireless Smart Controller and Receiver are to be installed indoors only, installation shall only be performed by suitably trained and qualified personnel, in accordance with local and national wiring rules.

This appliance is not intended for use by persons (including children) with reduced physical, sensory or mental capabilities, or lack of experience and knowledge, unless they have been given supervision or instruction concerning use of the appliance by a person responsible for their safety. Children should be supervised to ensure that they do not play with the appliance. If any cables are damaged, they shall be replaced by the manufacturer or its service agent or similarly qualified person in order to avoid a hazard.

Stranded conductors shall not be consolidated by lead-tin soldering where they are subject to contact pressure, i.e. on terminal block.

SAFETY

FCC COMPLIANCE

**Supplier's Declaration of Conformity
47 CFR § 2.1077 Compliance Information**

Unique Identifier: Wall Controller, Product Number 117911, FCC ID R2ESIA18
Receiver, Product Number 902869, FCC ID R2ESIA19

Responsible Party – U.S. Contact Information

Seeley International (Americas)
1002 South 56th Ave, Suite 101,
Phoenix, ARIZONA
85043

FCC Compliance Statement

This device complies with Part 15 of the FCC Rules. Operation is subject to the following two conditions: (1) This device may not cause harmful interference, and (2) this device must accept any interference received, including interference that may cause undesired operation."

NOTE: This equipment has been tested and found to comply with the limits for a Class B digital device, pursuant to part 15 of the FCC Rules. These limits are designed to provide reasonable protection against harmful interference in a residential installation. This equipment generates, uses and can radiate radio frequency energy and, if not installed and used in accordance with the instructions, may cause harmful interference to radio communications. However, there is no guarantee that interference will not occur in a particular installation.

If this equipment does cause harmful interference to radio or television reception, which can be determined by turning the equipment off and on, the user is encouraged to try to correct the interference by one or more of the following measures:

- Reorient or relocate the receiving antenna.
- Increase the separation between the equipment and receiver.
- Connect the equipment into an outlet on a circuit different from that to which the receiver is connected.
- Consult the dealer or an experienced radio / TV technician for help.

Any changes or modifications not expressly approved by the party responsible for compliance could void the user's authority to operate the equipment.

MOUNTING THE MAGIQTOUCH WIRELESS SMART CONTROLLER

LOCATION

The MagIQtouch Wireless Smart Controller should be placed approximately 1.5 metres (5') above the floor, in the most used room of the home.

Placement is critical for correct functioning of the temperature sensing thermostat inside the Controller.

The following must be taken into consideration:

- Avoid direct sunlight exposure.
- Avoid mounting on external walls.
- Avoid mounting the wall control near heat sources such as stoves and televisions.
- Do not locate in the direct airflow of the duct outlets.
- Do not locate in strong drafts or in dead spots such as cupboards / drawers.

CAUTION!

Always make sure there are no electrical cables, gas or water pipes, or the like, behind where you intend to drill.

MOUNTING THE MAGIQTOUCH WIRELESS SMART CONTROLLER

MOUNTING THE CONTROLLER

Remove the mounting bracket from the rear of the MagIQtouch Controller.

Step 1

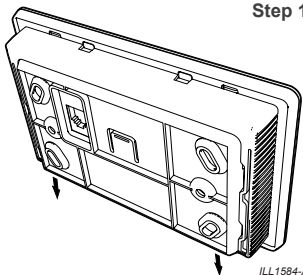

Step 2

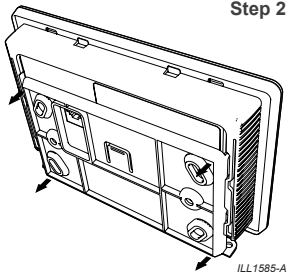

Step 3

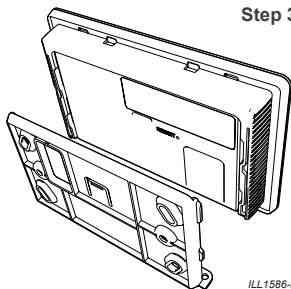

MOUNTING THE MAGIQTOUCH WIRELESS SMART CONTROLLER

Step 4

Using the bracket as a template, mark the centre points for the screw and cable access holes.

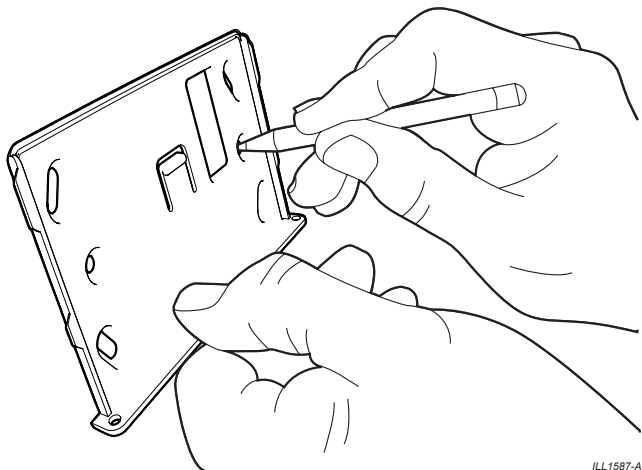

ILL1587-A

MOUNTING THE MAGIQTOUCH WIRELESS SMART CONTROLLER

Step 5

Insert wall plugs into holes. Align and screw the bracket into position using the supplied screws.

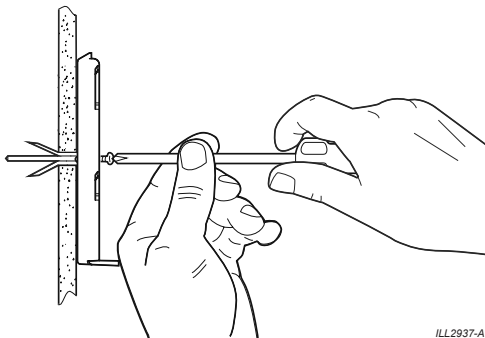

ILL2937-A

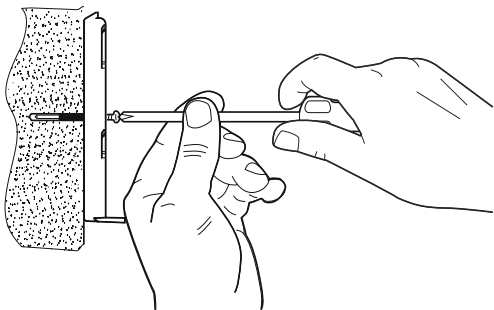

ILL2938-A

Alternatively, a standard stud mounting bracket (used for wall plates) can be used with plasterboard walls.

MOUNTING THE MAGIQTOUCH WIRELESS RECEIVER

We recommend installation of the wireless receiver (Antenna) inside the ceiling / floor space space, as far away from heating / cooling appliances and ductwork as possible and also as close as practical to the area of the building the remote controller will be used the most. Therefore, we request that the antenna is always straightened and pointing towards the remote.

IMPORTANT!

The wireless receiver is not designed to be installed outdoors!

Do not wrap any excess wireless receiver cable around the receiver. Do not extend the receiver cable.

HEATER INSTALLATION

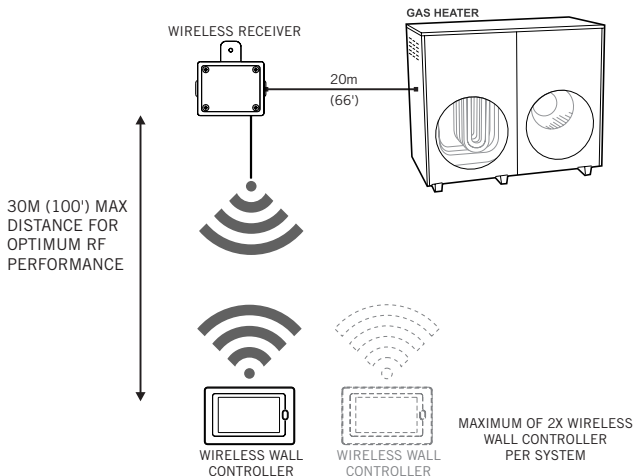

ILL2853-A

MOUNTING THE MAGIQTOUCH WIRELESS RECEIVER HEATER WITH ZONES - INSTALLATION

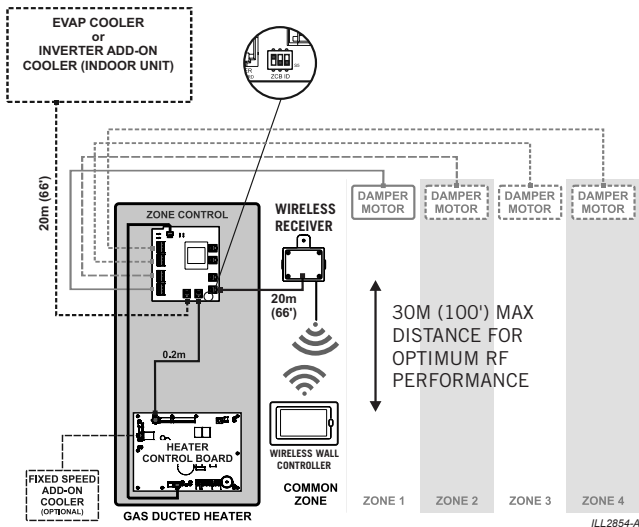

MOUNTING THE MAGIQTOUCH WIRELESS RECEIVER COOLER INSTALLATION

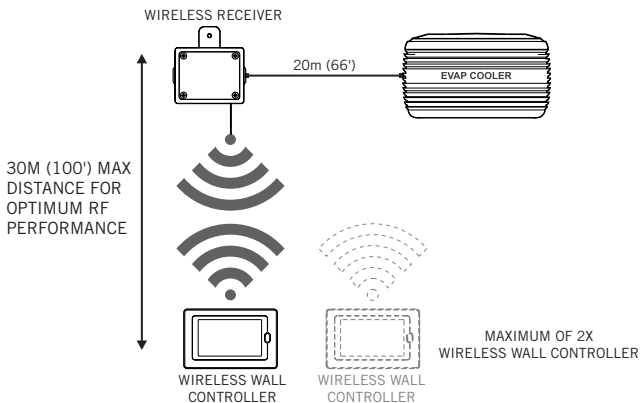

ILL2855-A

MOUNTING THE WIRELESS RECEIVER

For most installations, mounting the receiver as shown (Fig 1) will provide satisfactory performance.

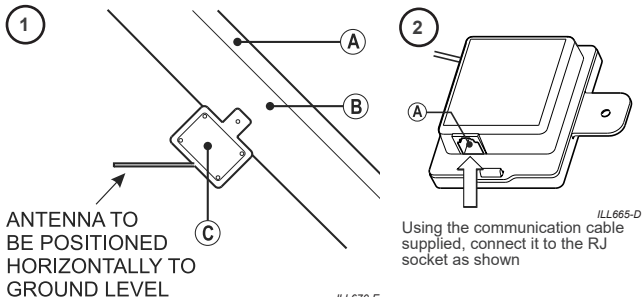

ILL665-D

ILL670-E

- A. Metal Roofing
- B. Wood or Metal Beam
- C. Receiver (mount as close as possible to a metal roof)

MOUNTING THE MAGIQTOUCH WIRELESS RECEIVER

For installations where the roof is framed with steel, resting the wireless receiver between joists and keeping the antenna as far away as possible and perpendicular (at right angles) to joists will give the best results. (Fig. 3)

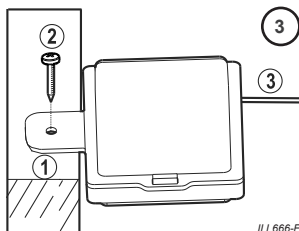

- 1 = Hold the receiver flat onto the ceiling beam
- 2 = Fix the screw through the tab
- 3 = Antenna must be extended horizontally



FOR OPTIMUM PERFORMANCE,
THE ANTENNA SHOULD BE
STRAIGHT AND PARALLEL
TO THE GROUND AS SHOWN

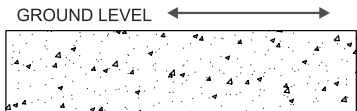

ILL2940-A

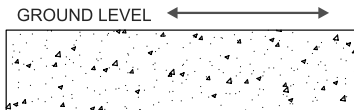
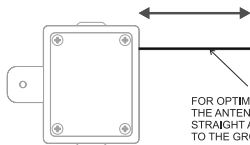

ILL2940-A

COMMISSIONING

- Factors that may influence performance are:
- Shielding from metal in the attic laying between the wireless receiver and the wireless smart controller.
- Reflections from metal around the wireless receiver.
- Interference from nearby transmitters (e.g. mobile phone, AM radio, Television, RF security systems)

CONNECTING THE WIRELESS RECEIVER

Please refer to the installation manual of the heating or cooling appliances for connecting the 6 pin communication plug from the wireless receiver. Some manuals may refer to a 'wired' wall control configuration. However, the wireless receiver can be connected in place of the wall control connection shown in the schematic diagrams.

PAIRING

Step 1

Fit the 4x AA batteries supplied with the Wireless Smart controller.

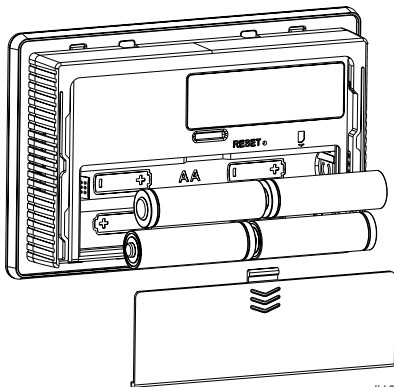

ILL2856-A

NOTE:

Rechargeable batteries should not be used.

Only good quality Alkaline or Lithium AA batteries to be used.

Step 2

Cycle the power to the installation.

COMMISSIONING

Step 3

Within 8 minutes of cycling the power, press the home button on the Wireless Smart Controller to activate it.

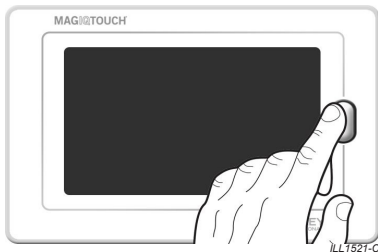

ILL1521-C

Step 4

Follow the on screen instructions to pair the wall control.



ILL2857-B



ILL2858-A

COMMISSIONING

Step 5

When the Wireless wall controller is paired the installation wizard will appear. The Installation wizard will step you through the complete process.



ILL1610-B

To complete the commissioning please refer to the 'MagIQtouch Controller - Installation manual supplied with this kit.

PAIRING ADDITIONAL WIRELESS CONTROLLER

The wireless receiver can communicate with 2x Wireless Smart Controllers within the system. During normal operation whichever wall controller is used last will take control of the system.

To pair an additional Wireless Smart Controller commence with the following steps.

Step 1

Fit the 4x AA batteries supplied with the Wireless Smart controller.

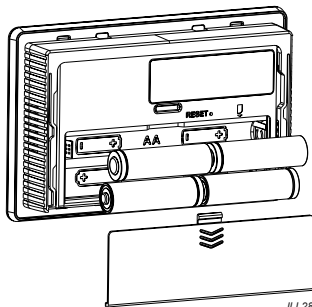

ILL2856-A

NOTE:

Rechargeable batteries should not be used.

Only good quality Alkaline or Lithium AA batteries to be used.

COMMISSIONING

Step 2

Cycle the power to the installation. This will make the Wireless receiver discoverable for a maximum of **8 minutes** to the Wireless smart controller.

Step 3

Select 'Additional Controller' to pair the second Wireless controller.



The additional wireless smart controller is now ready to use.

WIRELESS CONNECTION MAINTENANCE

Should the wireless communications require updates or modifications in the system, these can be accessed in the SERVICE section of the Wireless Smart controllers as follows;

Step 1

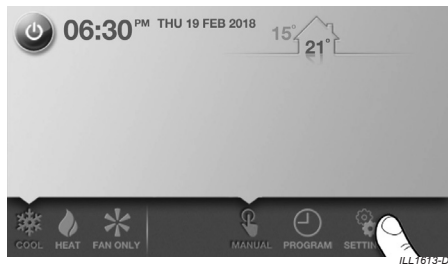

Step 2



WIRELESS CONNECTION MAINTENANCE

Step 3

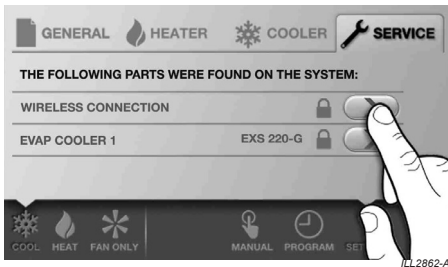

Step 4 Refer to MagIQtouch Wall control install manual for code.

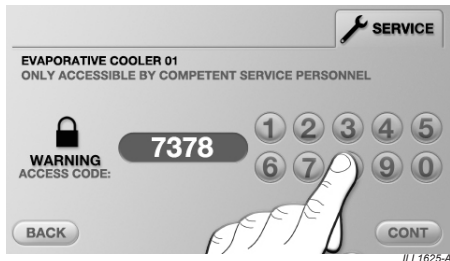

WIRELESS CONNECTION MAINTENANCE



ABOUT WIRELESS RECEIVER

Detailed RF signal strength (RSSI) and battery voltage (mV) information is displayed here.

CHECK / MODIFY WIRELESS CONFIGURATION

All known Wireless smart devices connected to the system will be shown. If devices are missing the wireless receiver can re-scan for wireless devices from this configuration screen to maintain the system.

RESET / REMOVE THIS CONTROLLER FROM THE SYSTEM

This option will safely remove a Wireless Smart controller from the system.

WIRELESS RECEIVER REPLACED

In the unlikely event the wireless receiver has to be replaced in the system, this option will load system configuration stored in the wireless smart controller to the new wireless receiver.

WIRELESS CONNECTION MAINTENANCE

WIRELESS RF SIGNAL RANGE

It is recommended to check the RF range of the wireless smart controller during commissioning to know the best positions / environments to maintain normal operation of the system & controller.

To check signal strength or range of the wireless smart controller it can be accessed as follows;

Step 1



Step 2



Step 3

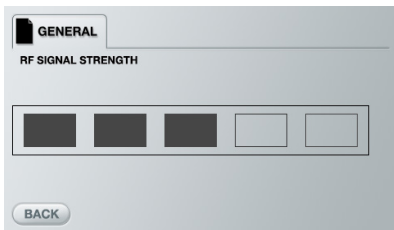

ILL2761-B

CONTROLLER OR SYSTEM RESET

It is possible to reset the whole system (including all connected components) or the MagIQtouch Controller only.

Use a pin or paperclip to press and hold the reset button located at the back.

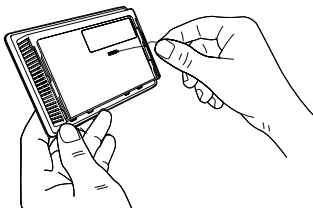

ILL1596-C

This will cause the following screen to appear:



ILL1632-A

Note! RESET WALL CONTROLLER ONLY

This option should only be selected if the wall controller connected was previously used in another installation.

RESET WHOLE SYSTEM

Resetting the whole system will set all components connected to the wall controller to default factory settings. When a system is reset it will be required to go through 'System Installation Wizard' again from the start, including pairing with the wireless wall controller to the wireless receiver.

CONTROLLER OR SYSTEM RESET

SYSTEM RESET WHEN 2X WIRELESS WALL CONTROLLERS ARE CONNECTED

Recommended sequence to reset the whole system when 2x wireless wall controllers are installed.

Step 1 Go to 1x “active” wireless wall controller

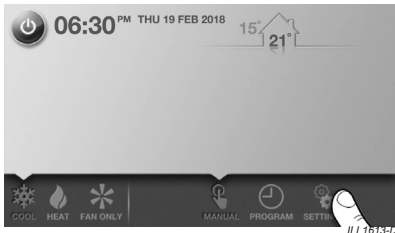

Step 2



Step 3

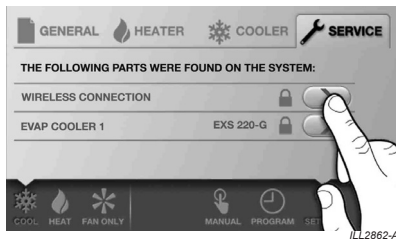

CONTROLLER OR SYSTEM RESET

SYSTEM RESET WHEN 2X WIRELESS WALL CONTROLLERS ARE CONNECTED

Step 4

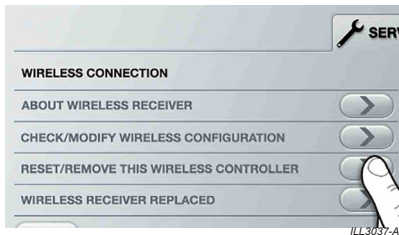

Step 5

When the screen shot below is displayed, go to the 2nd wireless wall controller



Step 6

Activate the 2nd wireless wall controller



CONTROLLER OR SYSTEM RESET

SYSTEM RESET WHEN 2X WIRELESS WALL CONTROLLERS ARE CONNECTED

Step 7



Step 8



Step 9

Pair controller and the Installation Wizard will begin.



SUPPORT

Symptom	Cause	Action
The MagIQtouch Wireless Smart Controller has no display	Batteries not fitted	Remove battery cover and fit 4x AA batteries
	Batteries not fitted correctly	Ensure batteries are orientated as shown inside battery cavity
	Batteries are low	Replace 4x AA batteries
	Controller in sleep mode	Press the Home button to the right of the screen
The MagIQtouch Wireless Smart Controller states 'This Controller has lost Communication!'	Wireless Smart Controller out of range	Check RF signal in 'SETTINGS'. Move controller closer to Wireless receiver.
	Appliance connected to Wireless receiver is switched off	Check power to the installation.
	Batteries in controller are low	Replace 4x AA batteries
The MagIQtouch Wireless wall controller will not pair	Installation has been powered up for longer than 8 minutes after 'Pair' is pressed on controller	Cycle the power to the installation to initiate the 8 minute 'discovery mode' on the wireless receiver and press 'PAIR' on wireless smart controller
	The Wireless receiver is not connected	Ensure the Wireless is connected and installed correctly in the installation circuit
	2x MagIQtouch Wireless controllers are already paired	Remove 1x Wireless controller from 'SERVICE' screen. Only a maximum of 2x wireless Smart controllers can be paired
	20m (66') communications cable supplied with kit is broken or damaged	Replace cable
	Wireless Smart Controller out of range to Wireless receiver	Move wireless receiver and Wireless Smart controller closer together.
The Installation wizard states 'No appliances found'	The wireless smart controller has been paired but the installation has been started after the initial 4 minutes of cycling the power	Cycle the power to the installation and press 'RETRY' on the wireless controller

SUPPORT

Symptom	Cause	Action
The screen on the Wireless Smart Controller goes blank after a while	The Smart controller conserves the battery life by putting the controller in a sleep mode	Press Home Button
The screen on the wireless Smart controller goes blank but the system still operates	The Smart controller conserves the battery life by putting the controller in a sleep mode	To check the status of the system press the 'HOME' button to the right of the Wireless smart controller to see the current running condition of the system
The additional Wireless Smart Controller does not allow me to adjust anything	The additional Wireless controller will display the operating condition of system	Press 'ACTIVATE' on wireless Smart Controller
Not achieving set temperature	The temperature is sensed at the controller. Check the location of the controller.	<ul style="list-style-type: none">• Avoid direct sunlight exposure• Avoid sitting wall control near heat sources such as stoves and televisions.• Do not locate in direct airflow of the duct outlets.• Do not locate in strong drafts or in dead spots such as cupboards or drawers.

USER GUIDE

USER GUIDE



Hello and congratulations on purchasing a MagiQtouch Wireless Smart Controller for your home!

The MagiQtouch Wireless Smart Controller is a versatile and intelligent Controller that can be used with a range of compatible products.

This manual is a supplement to the MagiQtouch Controller Owners Manual supplied with this Wireless controller. For more information about operating the MagiQtouch Wireless Smart Controller, please refer to the other Owners Manual supplied.



OWNER'S MANUAL MagiQTouch Controller



GENERAL TIPS

- Mount the MagIQtouch Wireless Smart Controller in a room you want climate controlled. Ideally it should be positioned 1.5m (5') from the floor and away from any other heating or cooling sources.
- Ensure the MagIQtouch Wireless Smart Controller is not exposed to direct sunlight as this will impact the temperature reading.
- Avoid blocking or restricting the vent holes located in the side of the MagIQtouch Controller, as this is where the thermostat is located.
- Do not use harsh chemical cleaners to clean the touch screen. For best results use distilled water or a touchscreen specific cleaning agent with a microfibre cloth.

REPLACING THE BATTERIES

Batteries are fitted to back of the controller as shown

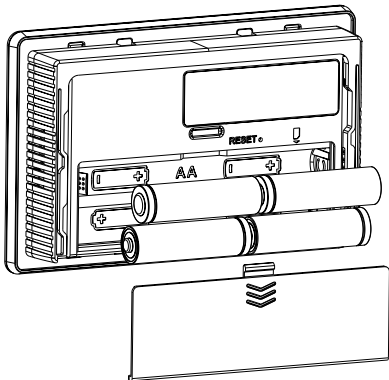

ILL2856-A

NOTE:

Rechargeable batteries should not be used.

Only good quality Alkaline or Lithium AA batteries to be used.

Replace batteries when this message is displayed



ILL2874-A

QUICK START

Here's a brief visual guide to get you started quickly!
Turning on the MagiQtouch Wireless Smart Controller.

STEP 1

Activate screen.

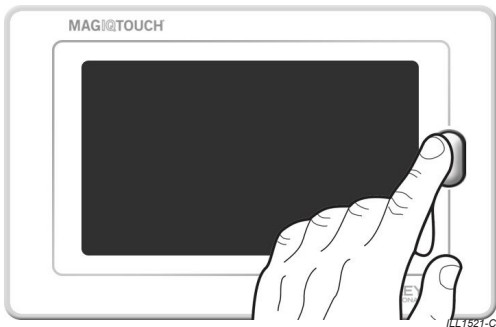

SLEEP MODE

If the Wireless controller is not touched for a period of time, it will go to a sleep mode where the screen will go blank. Simply push the “home” button to view the display.



ILL2875-A

WIRELESS RANGE

It is recommended for optimum performance to operate your Wireless Smart Controller within 30m (100') of the appliance.

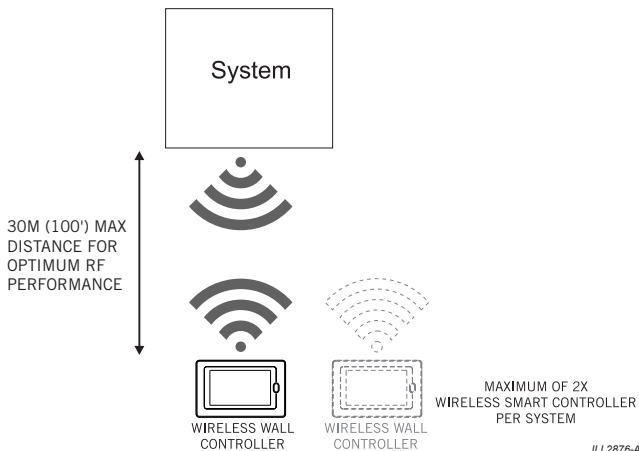

WIRELESS RANGE

To check the signal strength of your Wireless Smart Controller, follow these steps.

Step 1

Press "SETTINGS"

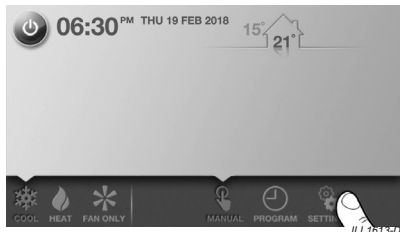

Step 2

Press "RF SIGNAL STRENGTH"



Step 3

RF Signal Strength display appears

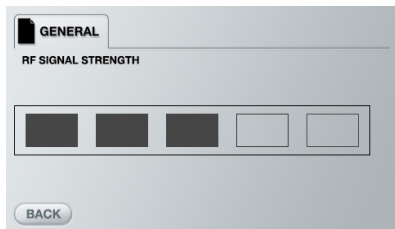

WIRELESS RANGE

As you move the wireless controller around your home it will be quite normal for the RF signal strength to change.

If the wireless control is out of range the following message will be displayed.



ILL2878-A

ADDITIONAL WIRELESS SMART CONTROLLER

If you have an additional Wireless Smart Controller installed in your system both controllers have the same operation and features.

The last controller used is the active controller

Wireless Controller No.

1 "ACTIVE"



Wireless Controller No.

2 "INACTIVE"



ADDITIONAL WIRELESS SMART CONTROLLER

To activate an 'INACTIVE' wall control press 'ACTIVATE'



The "Activate" button is displayed on the Inactive controller.



TROUBLE SHOOTING

Your MagIQtouch Controller may prompt you to call a service agent to resolve a service issue. If your Controller has only recently been installed, we recommend you call your local Dealer for support first. Otherwise, call the Service number on the back of this manual.

Symptom	Cause	Action
The MagIQtouch Controller has no display.	Batteries not fitted	Remove battery cover and fit 4x AA batteries. NOTE: Rechargeable batteries should not be used. Only good quality Alkaline or Lithium AA batteries are recommended.
	Batteries not fitted correctly	Ensure batteries are orientated as shown inside battery cavity
	Controller in sleep mode	Press the Home button to the right of the screen
The MagIQtouch Wireless Smart Controller states 'This Controller has lost Communication!'	Wireless Smart Controller out of range	Check RF signal in 'SETTINGS'. Move controller closer to Wireless receiver.
	Appliance connected to Wireless receiver is switched off	Check power to installation.
	Batteries in controller are low	Replace 4x AA batteries
The screen on the wireless Smart controller goes blank but the system still operates.	The Smart controller conserves the battery life by putting the controller in a sleep mode.	To check the status of the system press the 'HOME' button to the right of the Wireless smart controller to see the current running condition of the system.
The additional Wireless Smart Controller does not allow me to adjust anything.	The additional Wireless controller will display the operating condition of system.	Press 'ACTIVATE' on Wireless Smart Controller.
Not achieving set temperature.	The temperature is sensed at the controller. Check the location of the controller.	<ul style="list-style-type: none"> • Avoid direct sunlight exposure • Avoid sitting wall control near heat sources such as stoves and televisions. • Do not locate in direct airflow of the duct outlets. • Do not locate in strong drafts or in dead spots such as cupboards or drawers.



Warranty Service

Australia 1-300-650-644

Technical Support

Australia 1-300-650-399

For regions outside Australia:

Contact your local Dealer

seeleyinternational.com

MANUFACTURED BY: SEELEY INTERNATIONAL PTY LTD
112 O'SULLIVAN BEACH RD, LONSDALE SA, 5160. AUSTRALIA

IMPORTED BY: SEELEY INTERNATIONAL (EUROPE) LTD
*5 PAPPLEWICK LANE, HUCKNALL, NOTTINGHAM,
NOTTINGHAMSHIRE, NG15 7TN, UNITED KINGDOM*

SEELEY INTERNATIONAL (AMERICAS) LTD
*1002 S 56TH AVENUE, SUITE #101,
PHOENIX, ARIZONA 85043, USA*

SEELEY INTERNATIONAL (AFRICA) PTY LTD
*6 WITTON ROAD, FOUNDERSVIEW SOUTH,
MODDERFONTEIN 1609, GAUTENG, SOUTH AFRICA*

It is the policy of Seeley International to introduce continual product improvement.

Accordingly, specifications are subject to change without notice.

Please consult with your dealer to confirm the specifications of the model selected.

MAGIQTOUCH (⚡)

WIRELESS Next Generation Smart Controller

seeleyinternational.com

861794-F

AU 2104