

IMPORTANT! READ THIS FIRST BEFORE COMMENCING INSTALLATION

MULTI-MAGIC ROOM SENSOR INSTALLATION

This sensor measures the room temperature and relative humidity. It is intended for use with a compatible CW-80 or CW-H cooler.

Input Range

- Temperature: 0-10V = 0-50 °C / 32-122°F
- Relative Humidity: 0-10V = 0-100%

Recommended Cable Specification

The sensor requires 24VDC power and 2 signal wires.

- Instrumentation Cable with 4x 0.5mm² (AWG 20) conductors;
- Always route communication cables at least 300mm (12") away from high voltage cables and high-power machines.
- Crossover high power cables at right angles.

24VDC power can be supplied by the cooler (as shown) or a separate power supply (not included).

Cooler Input Terminals

Compatible CW-80 or CW-H coolers have a series of sensor input channels, configured in pairs and labelled S1/S2, S3/S4 (CW-H and CW-80) and S5/S6 (CW-80 only).

Always setup up the first channel (S1, S3 or S5) for temperature, and the second channel (S2, S4 or S6) for relative humidity.

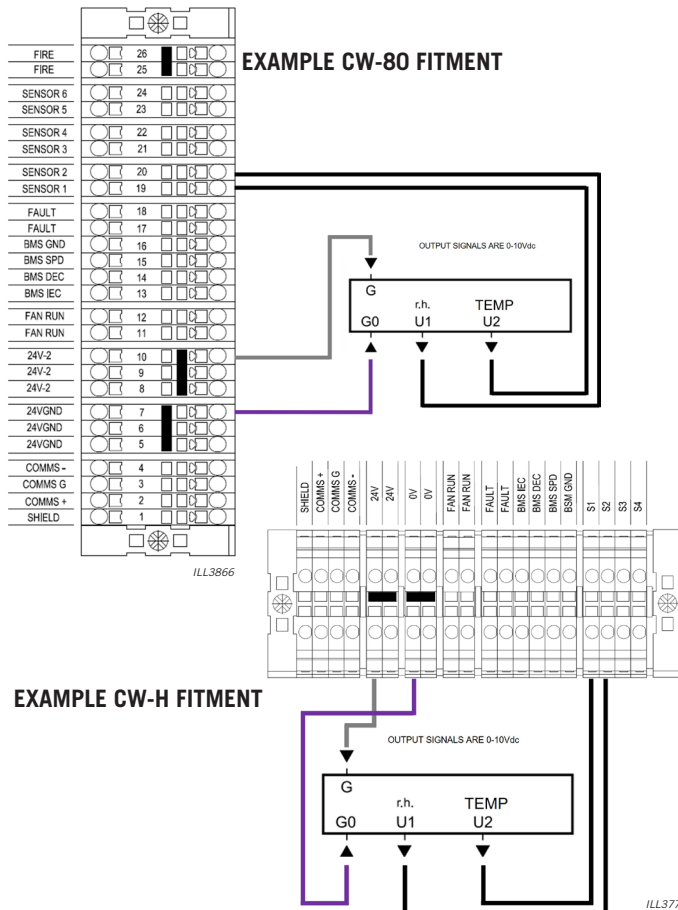

CONNECTING

After installation, use the LEFT/RIGHT buttons to navigate to the SENSORS screen on the cooler PLC screen.

Highlight the first sensor input channel for the connected sensor (S1, S3 or S5). Press OK and use the DOWN button to select ROOM-T. Press OK to confirm. ROOM-H will automatically be selected for the second sensor input channel (S2, S4 or S6).

Check the Temperature and R/H values on cooler PLC screen are present and correct.

Units can be changed between °C and °F in the PLC settings.

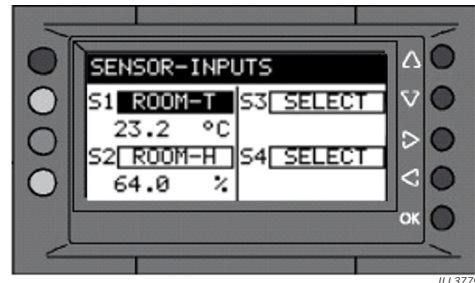

WALL CONTROLLER SETUP

When used in conjunction with a Multi-Magic Wall Controller, multiple room sensor inputs from multiple connected coolers are measured together to provide an average value for larger spaces.

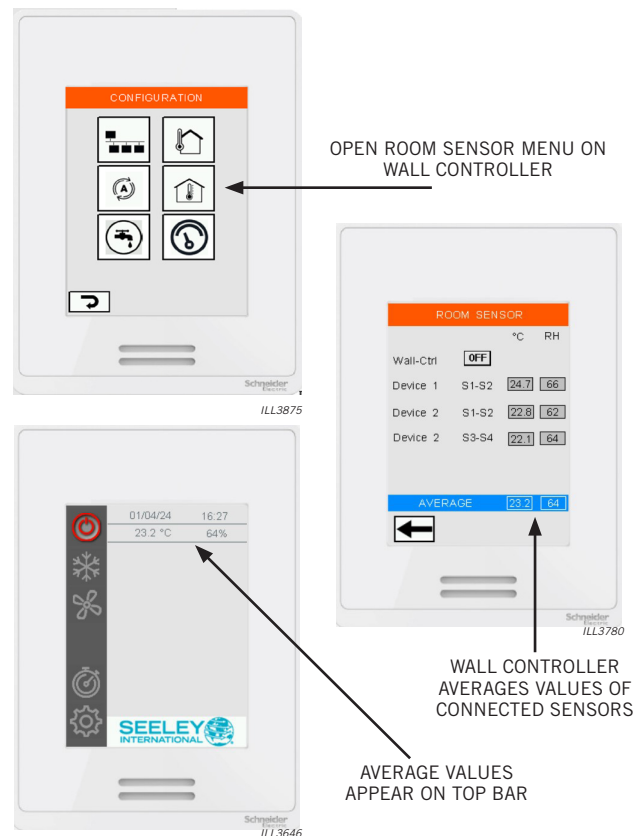

MULTI-MAGIC ROOM SENSOR INSTALLATION

EXAMPLE SETUP 1

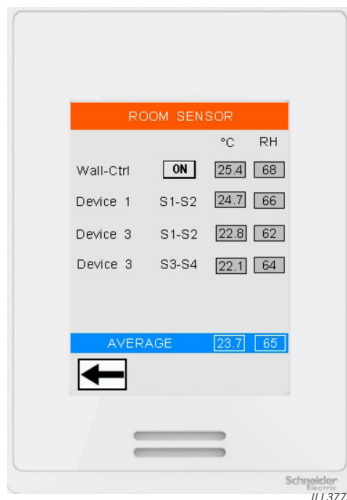
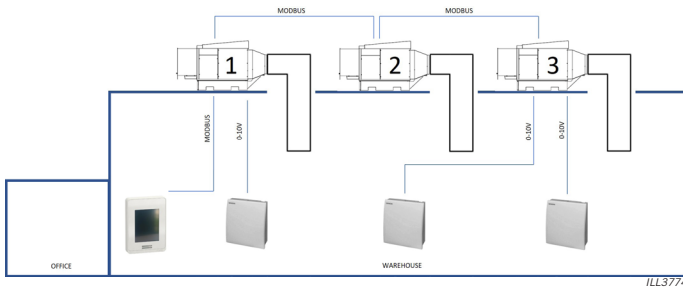

3x CW-H coolers are used to control internal warehouse space temperature.

3x Room Sensors are installed inside the space, one connected to Cooler 1 and two connected to Cooler 3.

Temperature and relative humidity values from the Wall Controller are set ON and all sensor values are averaged together on the Wall Controller.

ROOM SENSOR FAULTS (FAULT CODE 11)

If either Temperature or Relative Humidity inputs have been 0V (minimum scale) or 10V (maximum scale) for 10 minutes then the cooler will raise a Fault Code 11.

Sensors with an active fault will automatically be excluded from the averaging calculation and a red cross will appear next to their temperature and relative humidity values.

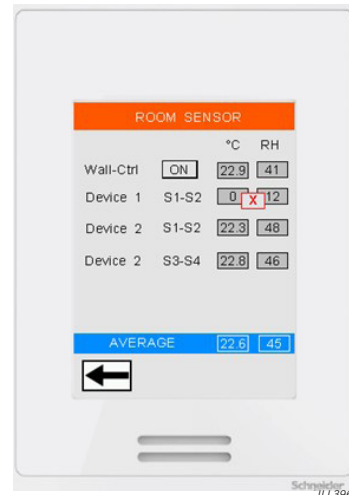

EXAMPLE SETUP 2

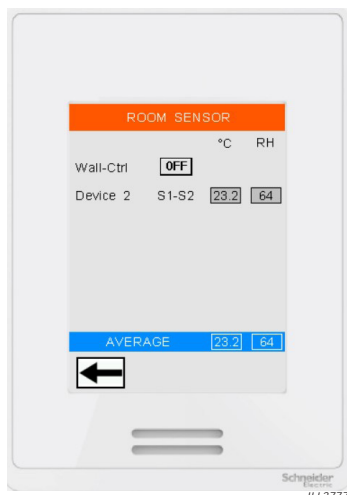
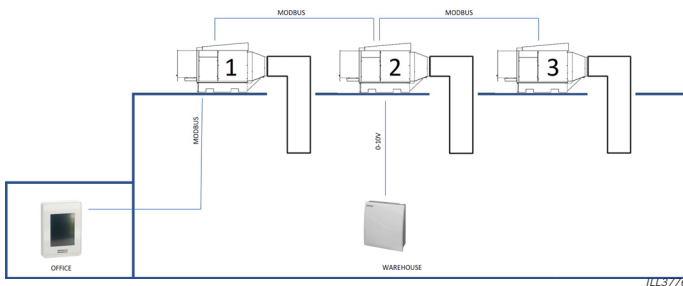

3x CW-H coolers are used to control internal warehouse space temperature, but the Wall Controller is installed inside a separate office.

A single Room Sensor is installed on Cooler 2.

Temperature and relative humidity values from the Wall Controller are set OFF and only the Room Sensor values are used

All other cooler control functions are still possible with the Wall Controller.

Warranty Service Australia
1300 650 644

For outside Australia contact your local dealer.

seeleyinternational.com

It is the policy of Seeley International to introduce continual product improvement. Accordingly, specifications are subject to change without notice. Please consult with your dealer to confirm the specifications of the model selected.