

INSTALLATION & OPERATION MANUAL

MagIQtouch BMS Industrial Controller MS1
(Coolers Only)

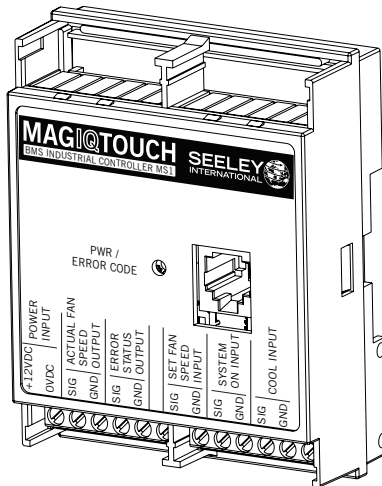





(English) (Industrial Controller MS1)

TABLE of contents

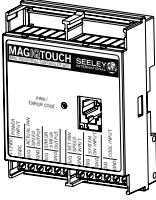
KIT CONTENTS	2
SAFETY	3
EMPLOYER AND EMPLOYEE RESPONSIBILITIES	3
Installer and Maintenance Contractors – Risk Assessment	3
Other Important Points to Consider:	3
INSTALLATION PREPARATION	4
COMMUNICATION CABLE	5
Master Mode - Maximum Cable Length	5
Slave Mode - Maximum Cable Length	5
INSTALLATION	7
Mounting - Din Rail	7
Mounting - Wall Mount	7
ELECTRICAL INSTALLATION	8
Typical Installation Options	8
Master Mode - Single Cooler	8
Master Mode - Multi Coolers	8
Slave Mode - Single Cooler Option 1	9
Slave Mode - Single Cooler Option 2	9
Slave Mode - Multiple Coolers Option 1	10
Slave Mode - Multiple Coolers Option 2	10
Master Or Slave Mode	11
Master Mode	11
Slave Mode	11
Activating Master Or Slave Mode	11
Connecting Cooler or Wall Control to BMS MS1	12
Inputs Signals	13
Voltage Levels for Set Fan Speed Analogue Input.	14
Output Signals	15
Error Status	15
Actual Fan Speed	16
Diagnostic LED's	17
CONNECTION DIAGRAM	18
TROUBLE SHOOTING	19

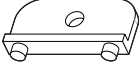
KIT CONTENTS

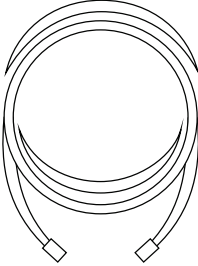
Contents			
Item	Images	Qty	Description
1		1	MagIQtouch Industrial Controller MS1
2		1	Installation and Operation Manual
3		2	Wall Brackets
4		2	Wall Plug Yellow 5mm
5		2	Screw PAN PHIL 6ABX1" ZNP
6		1	3m Communications Cable

ILL2109-A

SAFETY

This document provides technical guidance on the installation and operation of the MagIQtouch BMS Industrial Controller MS1.

EMPLOYER AND EMPLOYEE RESPONSIBILITIES

Please read this manual carefully. Your failure to do so could result in injury to you or damage to the cooler and property.

The installation and maintenance of coolers at height has the potential to create Occupational Health and Safety issues for those involved. Installers are advised to ensure they are familiar with Local Acts, Regulations and Standards, which may offer practical guidance on health and safety issues. Compliance with these regulations will require appropriate work practices, equipment, training and qualifications of workers.

INSTALLER AND MAINTENANCE CONTRACTORS – RISK ASSESSMENT

Seeley International provides the following information as a guide to contractors and employees to assist in minimising risk whilst working at height.

A risk assessment of all hazardous tasks is required under legislation. A risk assessment is an essential element that should be conducted before the commencement of work, to identify and eliminate the risk of falls or to minimise these risks by implementing control measures. There is no need for this to be a complicated process, it just is a matter of looking at the job to be done and considering what action(s) are necessary so the person doing the job does not injure themselves.

This should be considered in terms of:

What are the chances of an incident happening?

What could the possible consequence be?

What can you do to reduce, or better still, completely get rid of the risk?

WARNING!

The MagIQtouch BMS Controller requires an approved Safety Extra Low Voltage (SELV) 12Vdc power supply to be connected to the power supply input of the MagIQtouch BMS controller. The outputs from the controller require this approved SELV power supply in order to maintain the SELV circuit. Except for the RJ 6 way connection to the cooler, other inputs and outputs should only be connected to the SELV circuit of the building management system. Interconnection wiring between the MagIQtouch BMS controller and the building management system shall be separated by reinforced insulation to any live parts. Installation and location of the BMS controller shall be sufficiently separated from live parts to comply with reinforced insulation.

This MagIQtouch BMS Industrial Controller is to be installed indoors only, installation shall only be performed by suitably trained and qualified personnel, in accordance with local and national wiring rules.

This appliance is not intended for use by persons (including children) with reduced physical, sensory or mental capabilities, or lack of experience and knowledge, unless they have been given supervision or instruction concerning use of the appliance by a person responsible for their safety. Children should be supervised to ensure that they do not play with the appliance. If any cables are damaged, they shall be replaced by the manufacturer or its service agent or similarly qualified person in order to avoid a hazard.

Stranded conductors shall not be consolidated by lead-tin soldering where they are subject to contact pressure, i.e. on terminal block.

INSTALLATION PREPARATION

WARNING! THIS INSTALLATION SHOULD ONLY BE PERFORMED BY SUITABLY TRAINED AND QUALIFIED PERSONNEL, IN ACCORDANCE WITH LOCAL AND NATIONAL WIRING RULES.

Before commencing work on the cooler, ensure it is disconnected from the power source, when installing the MagIQtouch BMS Industrial Controller select and prepare an appropriate mounting site with the following features:

- Space for mounting on either DIN rail or directly to the wall.
- Clearance for inserting digital & analogue inputs & outputs.
- Within 100m of cooler.
- Dedicated 12Vdc power input for "Actual" fan speed and logic Error Status signal.

Note! Do not use power boards and double adaptors!

COMMUNICATION CABLE

The communication cable from the Cooler Controller to the MagIQtouch BMS Industrial Controller are 26AWG, 7/0.16, 6 core flat cable.

- 20m/66' cable is supplied with each Seeley cooler or heater.

Important! Supplied cables should not be altered. Failure of the product or components to operate correctly due to modification to supplied cables, or the use of non-approved cable will NOT be accepted under the Manufacturer's warranty.

MASTER MODE - Maximum cable length

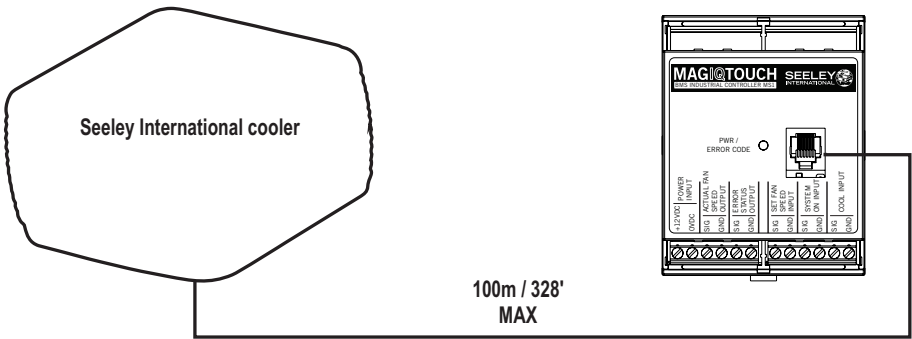

ILL2472-A

SLAVE MODE - Maximum cable length

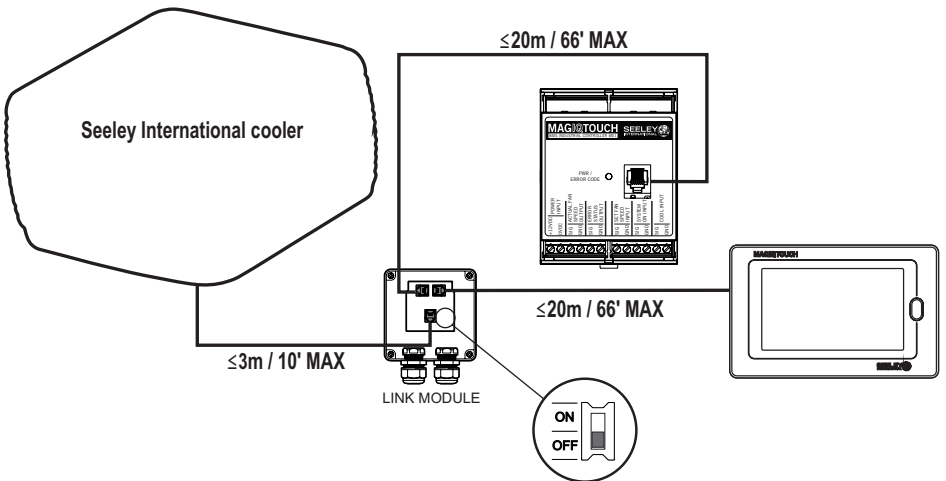

ILL2481-A

COMMUNICATION CABLE cont.

Should your installation require addition cables, 'genuine' Seeley International components can be ordered as follows;

Part No.	Length	Details
862873	1.5m/5'	MagIQtouch Industrial Wall Controller cable (No ferrite)
861265	3m/10'	MagIQtouch Industrial Wall Controller cable (No ferrite)
833880	20m/66'	MagIQtouch Industrial Wall Controller cable (No ferrite)
823553	20m/66'	MagIQtouch Industrial Wall Controller cable (ferrite)
864396	30m/98'	MagIQtouch Industrial Wall Controller cable (ferrite)
864402	40m/131'	MagIQtouch Industrial Wall Controller cable (ferrite)
834238	60m/197'	MagIQtouch Industrial Wall Controller cable (No ferrite)
834474	500m/1640'	Roll of 6 core ribbon cable with no terminations or plugs Plug Type = 6 pin Farnell 781-289, wired as below.
670423		Hinged Bracket Ferrite

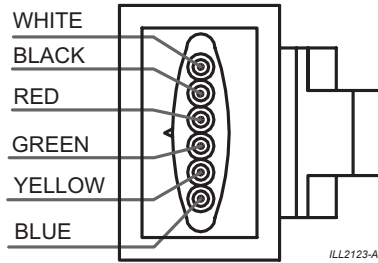

INSTALLATION

MOUNTING - DIN RAIL

BMS MS1 is suitable for internal installations only. The MagIQtouch BMS Controller is fitted with a DIN rail retainer on the rear of the enclosure. Locate the top catches onto the rail first, pivot down then secure the bottom catches onto the rail where the DIN rail retainer will click into place.

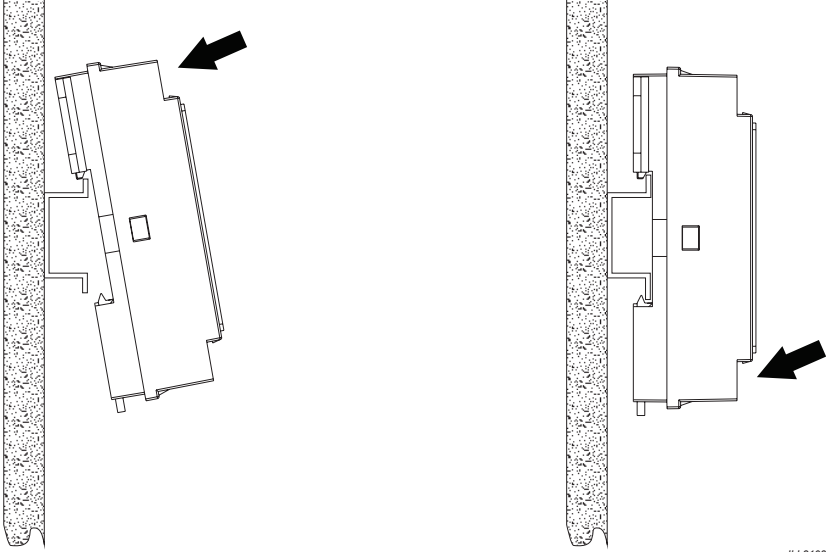

ILL2103-A

MOUNTING - WALL MOUNT

BMS MS1 is suitable for **internal** installations only. Within the MagIQtouch BMS Industrial Controller kit are 2 x wall brackets, push fit them into the each side of the enclosure base. Mark and drill suitable holes in wall and insert wall plugs provided. Align and screw the MagIQtouch BMS Industrial Controller on to the wall.

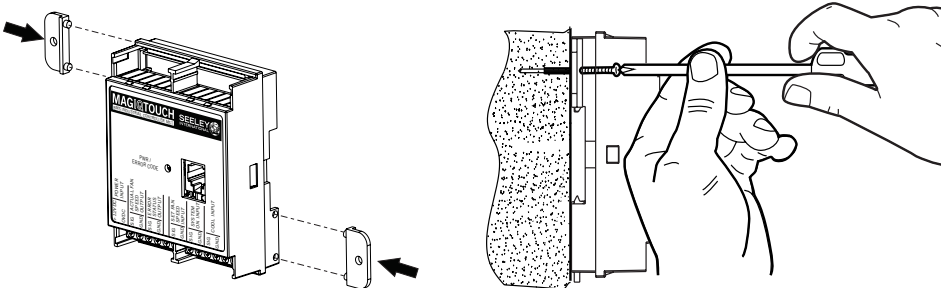

ILL2104-A

ELECTRICAL INSTALLATION

TYPICAL INSTALLATION OPTIONS

Installation of the cooler, wall controller and MagIQtouch BMS Industrial Controller must conform to local, national and international electrical safety and wiring regulations. Refer to the cooler installation manual for installation and electrical connection of cooler.

MASTER MODE - SINGLE COOLER

NOTE: 1 x BMS MS1 Master per 1 x cooler

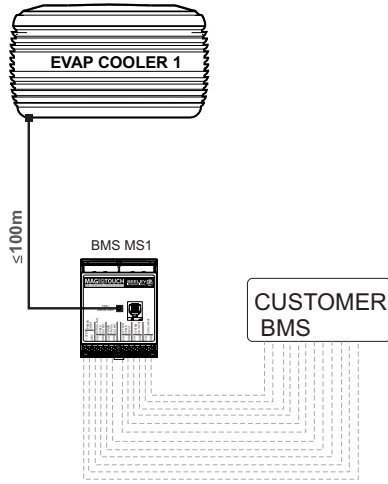

ILL2474-B

MASTER MODE - MULTI COOLERS

NOTE: 1 x BMS MS1 Master per 1 x cooler

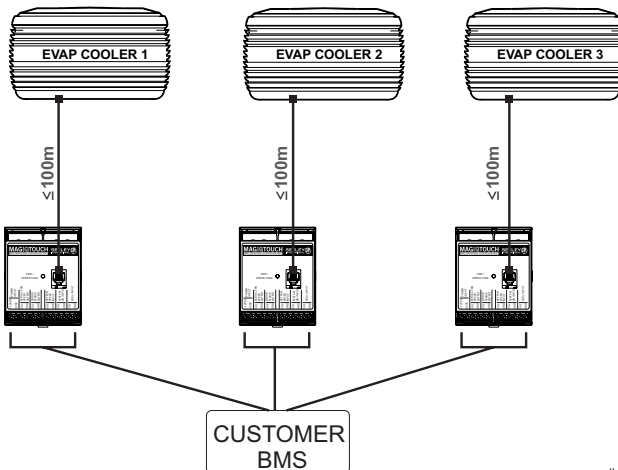

ILL2475-B

ELECTRICAL INSTALLATION cont.

SLAVE MODE - SINGLE COOLER option 1

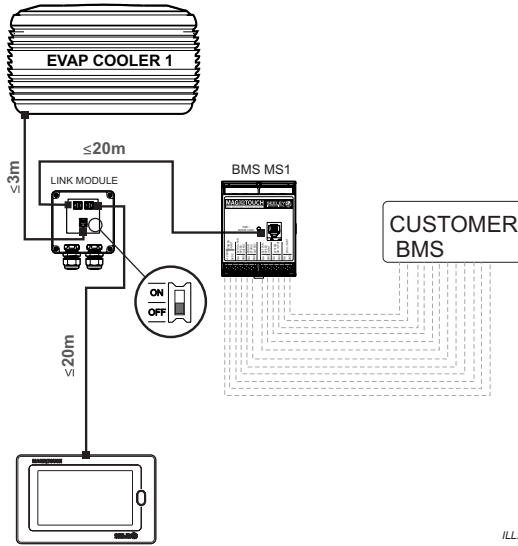

SLAVE MODE - SINGLE COOLER option 2

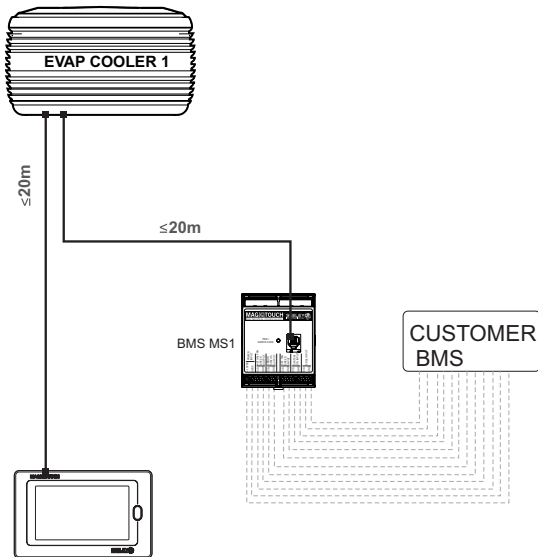

ELECTRICAL INSTALLATION cont.

SLAVE MODE - Multiple Coolers Option 1 (With link modules)

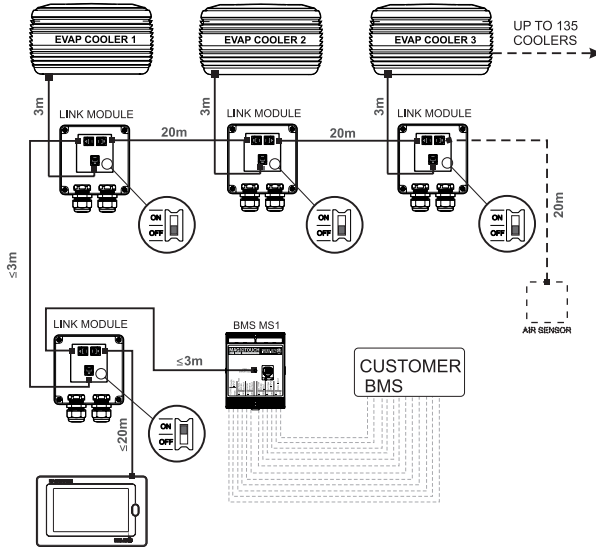

ILL2478-B

SLAVE MODE - Multiple Coolers Option 2 (With Dual RJ socket on Cooler electronics)

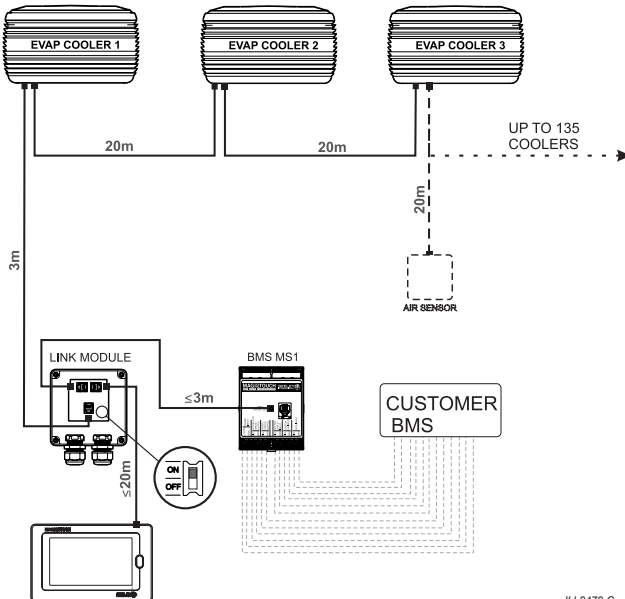

ILL2479-C

ELECTRICAL INSTALLATION cont.

Master or Slave Mode

The BMS MS1 controller can be used as either a 'Master' or 'Slave' Controller.

Master Mode

The BMS MS1 is controlled with BMS signals only and no MagIQtouch wall controller can be used. Only 1 x BMS MS1 per 1 x cooler can be used in this configuration.

Slave Mode

The BMS MS1 controller is a 'Slave' to the MagIQtouch wall controller. When the BMS MS1 'ON/OFF' signal is 'ON' the BMS MS1 controller takes control of the MagIQtouch wall control remotely. During remote access the MagIQtouch wall control will display "BMS CONTROL" and will not be operational.

Activating Master or Slave Mode

Remove the front cover of the BMS MS1 controller and set the dip switch to the requirements of your installation.

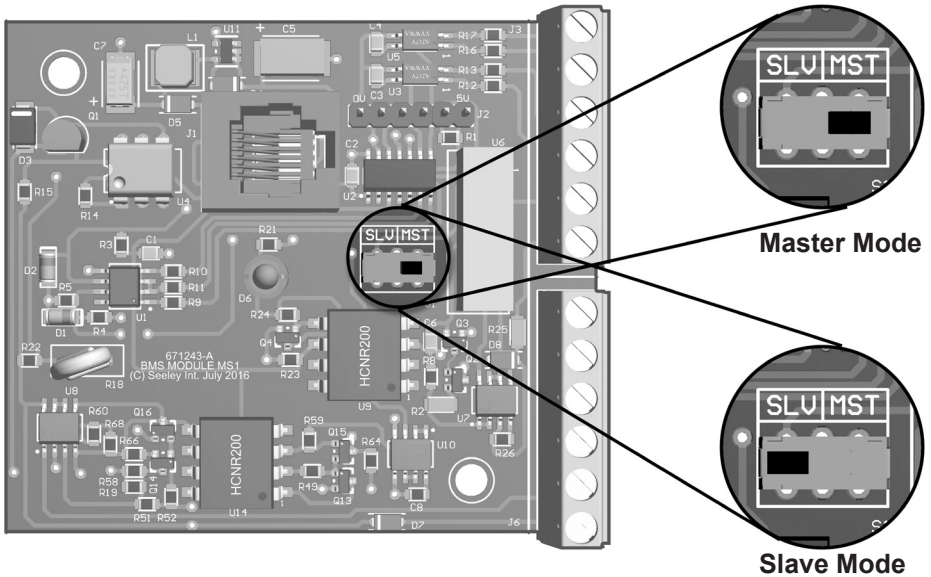

ILL2480-A

ELECTRICAL INSTALLATION cont.

CONNECTING COOLER OR WALL CONTROL TO BMS MS1

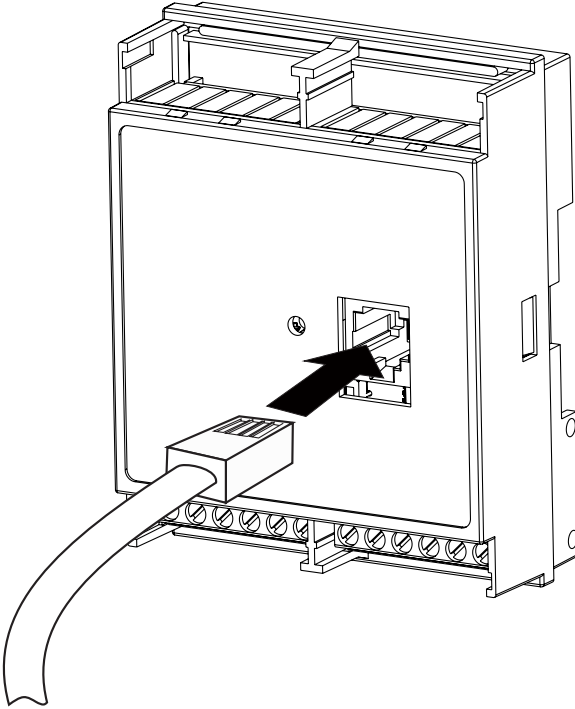

ILL2481-A

ELECTRICAL INSTALLATION cont.

INPUTS SIGNALS - DIGITAL

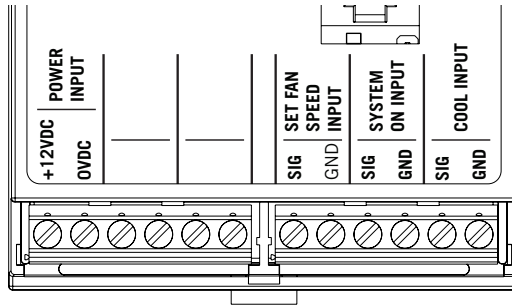

ILL2482-A

Name	Label	Function	Low	High	Input Type
On/Off	SYSTEM ON INPUT	Master mode only: Turn Cooler On or Off	Cooler Off	Cooler On	Digital 10Vdc
		Slave mode only: Switch operation between Wall control and BMS	MagIQtouch Control	BMS Control	Digital 10Vdc
Operation Mode	COOL INPUT	Cool or Vent	Fan Only	Cool Mode	Digital 10Vdc
Fan Speed	SET FAN SPEED INPUT	Set speed from 1-10	N/A	N/A	Analogue 0 - 10Vdc

Recommended voltage level for digital inputs.

Logical Level	Min	Typ.	Max	Unit
Low		0	2	Vdc
High	4	10	12	Vdc

ELECTRICAL INSTALLATION cont.

INPUTS SIGNALS - ANALOGUE

Recommended voltage levels for Set Fan Speed analogue input.

Set Fan Speed	Increasing (0 - 10)	Decreasing (10 - 0)
0	▼	0
1	2.8	2.2
2	3.6	2.8
3	4.4	3.6
4	5.2	4.4
5	6.0	5.2
6	6.7	6.0
7	7.5	6.8
8	8.2	7.5
9	9.0	8.3
10	10.0	▲

[Optional] 12Vdc power input (POWER IN 12VDC)

Power input only required if ACT FAN SPEED and ERROR STATUS signals are required from the module.

If Power input is not connected, ERROR STATUS and ACT FAN SPEED will not work.

	Min	Typ.	Max	Unit
Voltage DC	11.5	12	12.5	V

ELECTRICAL INSTALLATION cont.

OUTPUT SIGNALS - ERROR STATUS

The diagram shows the internal circuit of the Error Status output.

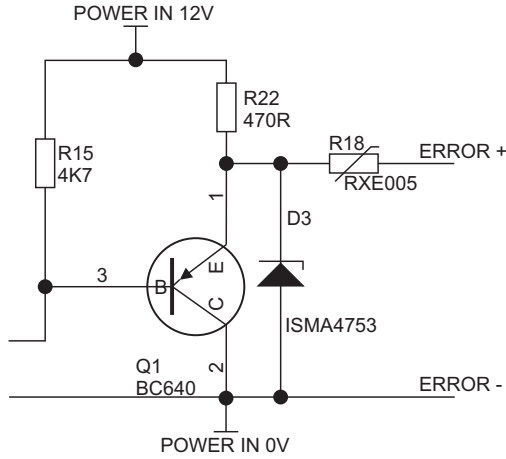

ILL2483-B

- The Error Status output can either be used to drive a relay coil...

RELAY COIL

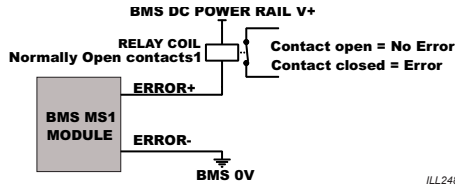

ILL2484-B

- or an output signal that can be directly monitored.

DIRECTLY MONITORED

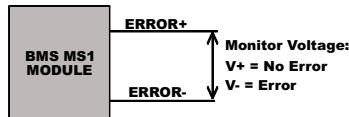

ILL2485-B

ELECTRICAL INSTALLATION cont.

OUTPUT SIGNALS - ACTUAL FAN SPEED

Actual Fan Speed	VOUT min	VOUT typ	VOUT max
0	0.0	0.8	1.0
1	1.0	1.3	1.6
2	1.7	2.2	2.5
3	2.7	3.2	3.5
4	3.7	4.2	4.5
5	4.7	5.2	5.5
6	5.7	6.2	6.5
7	6.8	7.2	7.5
8	7.8	8.2	8.6
9	8.8	9.3	9.6
10	9.8	10.3	12.0

Exact voltage levels may differ depending on the precision of the POWER IN 12V supply.

DIAGNOSTIC LED's

PWR / ERROR CODE LED

Diagnostic and cooler operating information can be viewed from the MagIQtouch BMS Industrial Controller via the Error Code LED's.

When power is applied to the RJ port of the BMS module MS1 and no error is detected the LED will illuminate continuously.

If an error is detected by the controller, the 'ERROR STATUS' LED will start illuminating on the front panel. The type of error will be indicated by the sequence of flashes highlighted on 'ERROR CODE' LED.

Errors can be cleared by applying a low level and then high level on the 'SYSTEM ON INPUT'.

Error codes can be cleared using the "RESET" button on the front of the controller.

- **OFF:** BMS Module Off (no power received from Cooler on RJ port).
- **ON:** BMS is operational (Communication to Cooler and Wall Control OK, Cooler has no faults).
- **Flashing:** cooler has a fault, number of flashes corresponds to Fault Code (i.e.: 2 flashes => FC02).

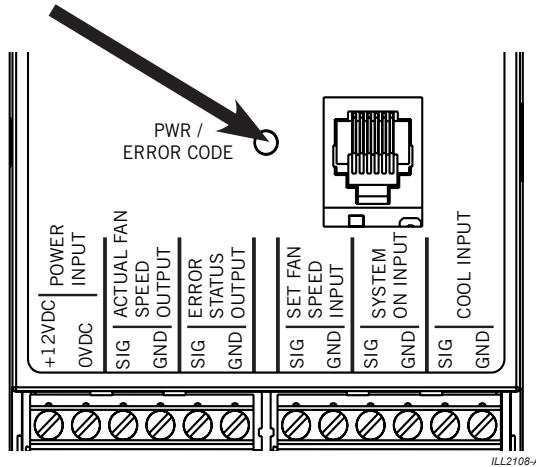

Part No.	Error
1 Flash	Fault Code #1 Communication Failure.
2 Flashes	Fault Code #2 Failure to Detect Water at Probes.
4 Flashes	Fault Code #4 Failure to Clear Probes during drain.
7 Flashes	Fault Code #7 Motor Fault

NOTE: Error Codes can vary between products. Refer to the cooler Installation Manual.

CONNECTION DIAGRAM

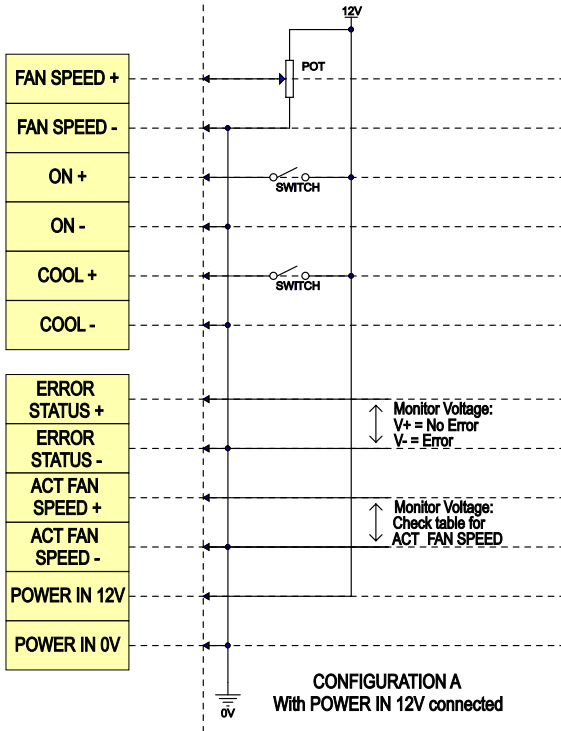

ILL2512-B

TROUBLE SHOOTING

Symptom	Cause	Action
The PWR LED is not illuminated.	Cable not connected correctly	Refit cable. Cycle power to cooler.
	Cable damaged or broken.	Replace cable. Cycle power to cooler.
The PWR LED is flashing (1-flash sequence).	The BMS MS1 configured in incorrect mode (Master/Slave).	Open enclosure and correct dipswitch position. Cycle power to Cooler.
	Cable not connected correctly	Refit cable. Cycle power to cooler.
	Cable damaged or broken.	Replace cable. Cycle power to cooler.
The PWR LED is flashing (multiple flashes sequence).	The cooler has a fault.	Refer to cooler manual to solve the fault on the cooler. Cycle power to cooler.
The PWR LED is illuminated but the Cooler is not starting.	The ON input is not set to High.	Set ON input signal to High.
The ACT FAN SPEED OUTPUT signal stays always low.	The 12VDC power input is not connected.	Connect 12VDC between POWER IN 12VDC and POWER IN 0VDC.



Warranty Service

Australia 1-300-650-644

Technical Support

Australia 1-300-650-399

For regions outside Australia:

Contact your local Dealer

seeleyinternational.com

MANUFACTURED BY:

*Seeley International Pty Ltd, 112 O'Sullivan Beach Road, Lonsdale, SA 5160, Australia
(for Australia, USA, Europe and South Africa)*

IMPORTED BY:

*Seeley International (Americas) Ltd, 1002 S 56th Avenue, Suite# 101
Phoenix, Arizona 85043, USA*

*Seeley International (Europe) Limited, Unit 11 Byron Business Centre, Duke Street,
Hucknall, Nottingham, NG15 7HP, United Kingdom*

*Seeley International Africa (Pty) Ltd, 6 Witton Road,
Foundersview South, Modderfontein 1609, Gauteng, South Africa*

It is the policy of Seeley International to introduce continual product improvement.
Accordingly, specifications are subject to change without notice.
Please consult with your dealer to confirm the specifications of the model selected.



MAGIQTOUCH[®]
BMS INDUSTRIAL CONTROLLER MS1